

OCTOBER 1962

TAPE

RECORDING MAGAZINE

1/6

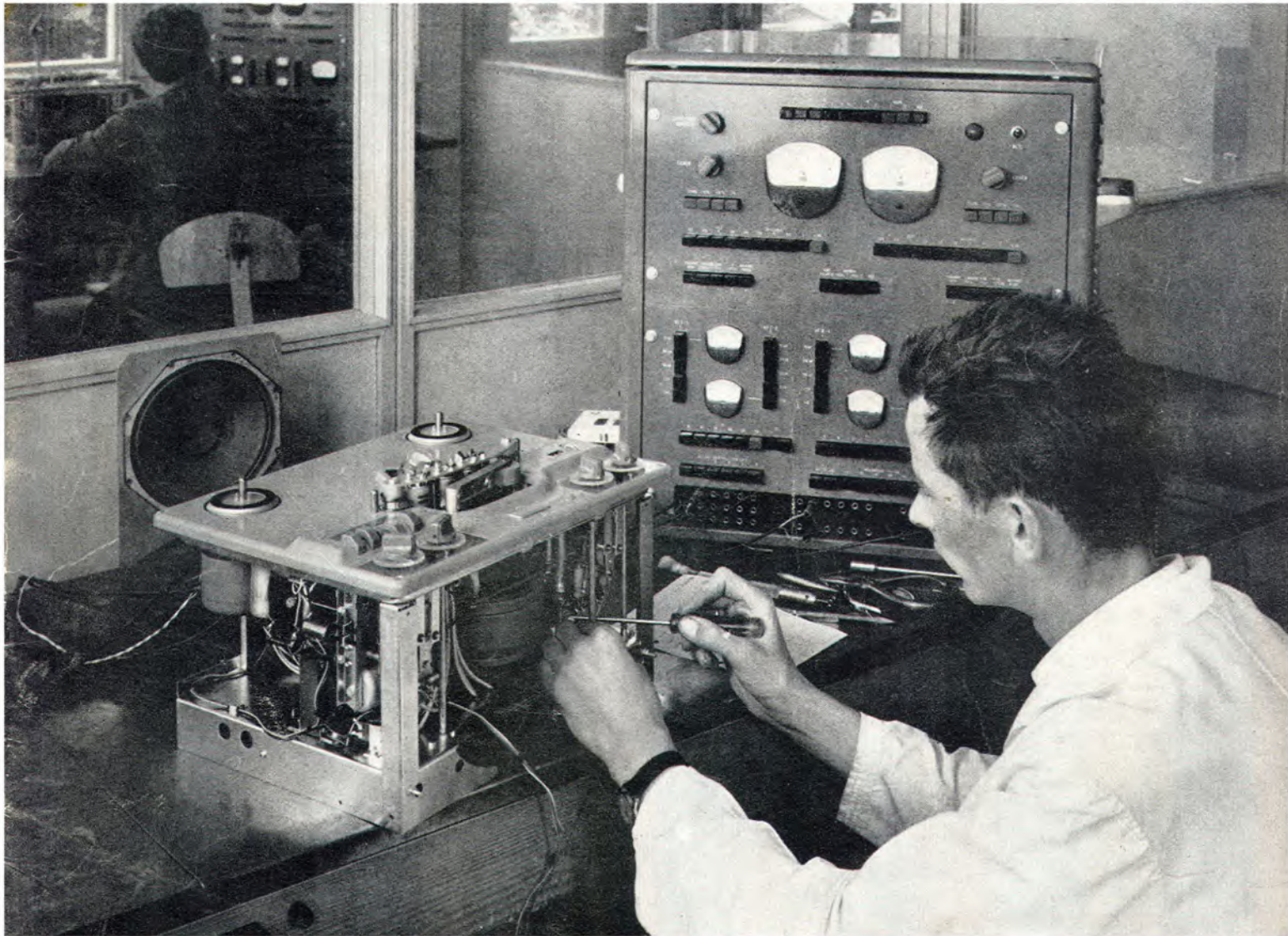

FIRST AND FOREMOST IN THIS FIELD

HOW TO
INTERVIEW
ON TAPE

U.S.A's 3rd LARGEST SELLER NOW ARRIVES IN BRITAIN!

AKAI Terecorders

for those who expect the earth in a world of sound



MODEL 69 'DE-LUXE'

Wide Frequency Range: Equipped with a record/play head which consists of specially treated core-materials being imported from West Germany.
Output Power: 6 watt, can drive larger size extension speaker up to 12 in. Self-contained speaker is 6 1/2 in. in diameter.
7 in. Reel Capacity: Accepts 3 in. and 5 in. reels as well.
Level meter: with pilot lamp for easier determination of correct volume control setting when recording.
Index (Revolution) Counter.
Instant Stop Control: Spot editing and momentary stops are easily accomplished by use of the instant Stop Lever.
Monitoring and better reproduction: Monitoring of your recording may be accomplished by plugging a crystal earphone into the recorder's Output Jack. Superb reproduction can be obtained by operating a large Hi-Fi speaker direct from the Output Jack. Also your existing power-amplifier that does not have a pre-amplifier of its own may be driven from the same Jack.

Head Output and three position Power Switch: If desired, the tape transport mechanism (tape deck) of the recorder can be operated independently of the built-in amplifier and speaker. The Head Output Jack and the three-position Power Switch are provided to make this special function possible.

Retails at 79 GNS.

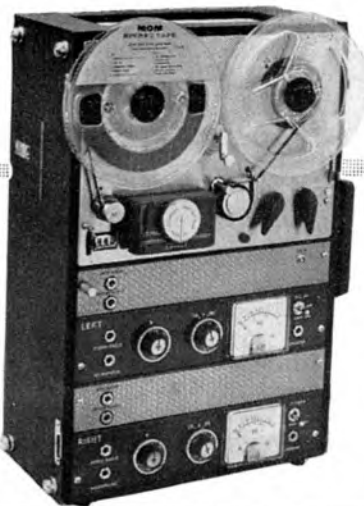

MODEL M6

Records and plays back either 4-track stereophonically or 4-track monophonically and also plays back 2-track prerecorded stereo tapes. Hysteresis Synchronous Motor always ensures constant tape speed. Designed for vertical or horizontal operation. Two inline and accurate V.U.-Meters reads recording and playback levels.

A precision Index Counter. Recording/play head consists of specially treated core-materials which are being imported from West Germany. Maximum output power of the built-in amplifier is 6 watt on each channel (total 12 watt) which can drive up to 12 in. extension speaker system. Dual Head and Preamp Outlets are provided for connection direct to any other pre-amplifiers or stereophonic amplifier.
Instant Stop Lever. All operating controls are interlocked.
Automatic stop device.

The pinch wheel is always automatically released from capstan which protects it against a "spot" on the soft rubber surface causing uneven running.

Retails at 130 GNS.

HI-FI WIDE RANGE STEREO SPEAKER SYSTEM MODEL SS-50

Matched with the Model M-6 in styling and size, complete with connecting cables.

Speakers: Two 8-inch mechanical 2-way (with built-in coaxial tweeter) speakers in a dividable carrying case.

Retails at 30 GNS



Akai's new modern factory in Japan, where the finest equipment is produced under the most up-to-date conditions.

Akai* is the most important contribution that has been made to first-class tape recording equipment for years. In a comparatively short time, they have established themselves in a leading position in the American Tape Recording field.

Now they have come to Britain and one has only to examine them to see why they are going to prove serious competition to those European manufacturers, who have led the field for so long. You find this hard to believe? Then see the Akai Terecorders for yourself, contact your usual dealer or the sole importers.

*Due to trade agreements Akai are sold under the name of Roberts in the U.S.A.

For descriptive literature and full information of the Akai Terecorders contact your usual dealer or **NORTHGATE (CAMERAS) LIMITED**, 119/125 Wardour Street, London, W.1
 Tel.: GERard 7030, 7038, 7939.

2 YEARS FREE SERVICING!!

**FREE GIFTS, FREE TAPES,
COMMISSION & DISCOUNTS!!!**

If that's what you want when you buy a tape recorder then you most certainly will not come to us to purchase one. We cannot and will not give you these things for our reputation as Britain's leading tape recorder specialist company is not built on sales gimmicks but on SERVICE. What we do give you is two whole years of worry-free, trouble-free and above all cost-free servicing. Every new tape recorder over £35 carries our unique and exclusive two years' absolutely FREE SERVICING GUARANTEE, that many thousands of more than satisfied customers have found to be the best obtainable anywhere. Make your choice when buying that new tape recorder. Gimmicks or superlative free servicing by a company specialising in nothing but recorders and servicing.

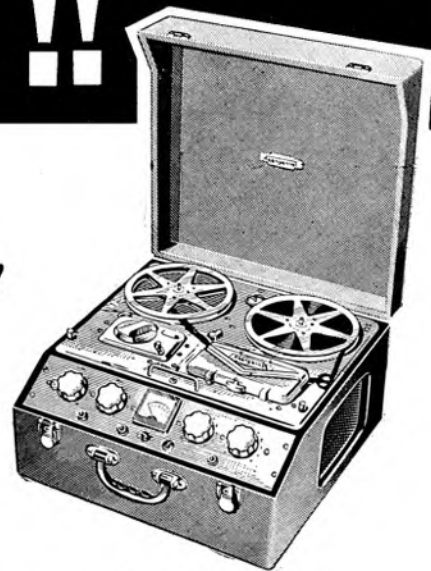

Specialists in

FERROGRAPH . VORTEXION
BRENELL . REFLECTOGRAPH
GRUNDIG . REPS . ETC

- ★ OVER 250 NEW AND LOW PRICED SECOND-HAND RECORDERS ON DISPLAY ★
- ★ GENEROUS PART EXCHANGES ★ CASH & H.P. TERMS OVER 9-24 MONTHS ★
- ★ FREE HOME DEMONSTRATIONS ★ FREE DELIVERY ★ FREE PAMPHLETS, Etc. ★

SHOWROOMS:

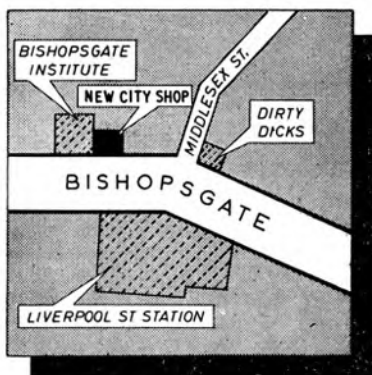

◀ CITY:

228 BISHOPSGATE, E.C.2 (Opp. Liverpool St. Station). BIS 2609
OPEN MON. to FRI. 9 to 6 p.m. CLOSED SATS. OPEN SUN. 9 to 2-30 p.m.

STRATFORD:

2 MARYLAND STATION, LONDON, E.15 (Adj. Maryland Station)
(EAST HAM & STRATFORD OPEN ALL DAY SAT.) MAR 5879

EAST HAM:

205 HIGH ST. NORTH, E.6 (Opp. East Ham Station). GRA 6543

CITY & ESSEX TAPE RECORDER CENTRES



**connoisseurs
say**

SIMON



... the connoisseur with an eye for a bargain chooses the **SIMON SP5** because no other tape recorder in the price range gives him so much at professional standards!

Unrivalled facilities of the **SIMON SP5** include uni-directional twin track recording, two speeds, 7-inch spools, dual channel mixing, master fader, monitoring through loudspeaker and level setting, controlled echo, track to track recording, controlled bias, recording level meter.

* You can buy the **SIMON SP5** as a stereo recorder, or in a monaural version ready wired and fitted for easy conversion to stereo.



SIMON SP5
Price from 95 gns
"Tape recording in the new age"



... the connoisseur with an ear for performance chooses the **SIMON Cadenza Ribbon Microphone** because he gets studio class results in the middle price range.

The **SIMON Cadenza Ribbon Microphone** is a popular and successful conception of ribbon and magnet arrangement... output is flat to close limits over the very wide range 50-12,000 c.p.s., new shell design eliminates resonant peaks and troughs—especially the "bass hump". Can be used in LZ or HZ condition... though the ribbon area is four times the normal size, dynamic impedance is negligible.



**SIMON Cadenza
Ribbon Microphone**
Price 10 gns
"Makes a piano sound like a piano"

For full technical details of SIMON tape recorders and microphones, consult your dealer. In case of difficulty please write to:

SIMON EQUIPMENT LIMITED
48 GEORGE STREET LONDON W.1

Magnetic Recording Tapes



on pre-stressed Polyester base. Excellent mechanical properties and outstanding electro-magnetic characteristics.

Distortion free. Maximum tensile strength.

Unaffected by variations in temperature.

Anti-static qualities ensure perfect sound reproduction.

- PE 31 LONG PLAY
- PE 41 DOUBLE PLAY
- PE 65 TRIPLE PLAY

	Length feet	Spool diameter ins.	Playing Time Double track at 9.5 cm/sec. 3½ ins./sec. Mins.	Price
Agfa PE 31	210	3	2 x 11	9.0.
Long play tape	900	5	2 x 45	£1. 8.0.
	1200	5½	2 x 60	£1.15.0.
	1800	7	2 x 90	£2.10.0.
Agfa PE 41	300	3	2 x 15	13.9.
Double play tape	1800	5½	2 x 90	£2.17.6.
	2400	7	2 x 120	£3.16.6.
	Agfa PE 65	450	3	2 x 23
Triple play tape	900	4	2 x 45	£1.19.0.
	1800	5	2 x 90	£3. 6.3.

AGFA LIMITED • 27 REGENT STREET • LONDON SW1 • PHONE REGent 8581/4

*Regd. Trademark

4 REASONS THAT MAKE THE **Garrard** TAPE SYSTEM SO SIMPLE

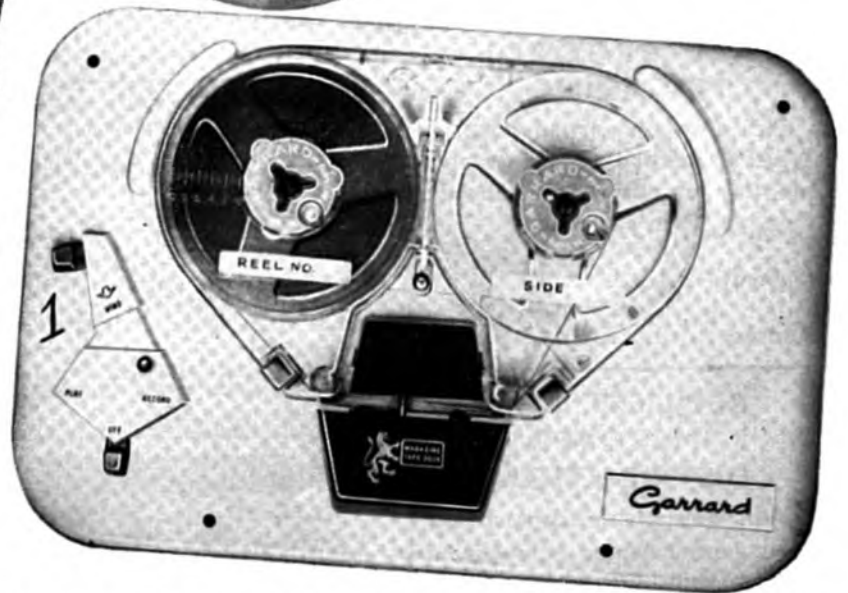
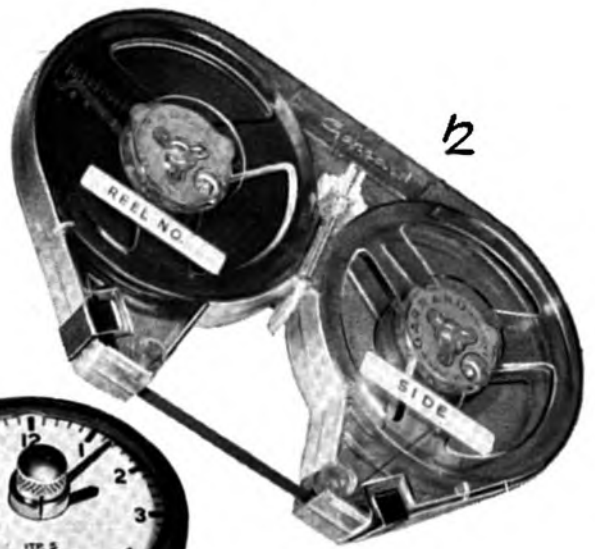

- 1 SIMPLE TO OPERATE**
Anyone can operate the Garrard system. Controls have been simplified. There are three positions only—PLAY · RECORD · WIND.
- 2 MAGAZINE LOADING**
No tape threading. No spilling. No anchoring of tape. Just place the magazine on the deck and it's ready to operate.
- 3 EASY STORAGE**
The Magazine is the same size as an average book. It fits neatly on a bookshelf using the Library Storage Unit.
- 4 GARRARD TAPE POSITION INDICATOR**
Gives precise and accurate indication of recordings on the tape.

CONTINUOUS—EASY TAPE RECORDING & PLAYBACK WITH THE GARRARD MAGAZINE METHOD

MAGAZINE TAPE DECK ACCESSORIES

	£	s.	d.
Magazine containing 650 ft. Double Play Tape in container	1	13	4
Magazine only with one empty spool	8 0
Reel of 650 ft. Double Play Tape	1 4 0
Garrard Spool only	3 3
Library Storage Magazine Container	3 6
Tape Position Indicator	1	19	6

THE GARRARD ENGINEERING & MANUFACTURING CO. LTD.
SWINDON · WILTSHIRE

THE SOUND OF **SONY**... A WONDERFUL SOUND



The **SONY** 521 Stereophonic Tape Recorder

Here is brilliant engineering in sound. The Sony 521. Here is perfection in dimensional recording and reproduction. The Sony 521. Here are the many extras usually reserved for professional instruments—built-in amplifiers and speaker units, two and four track play-and-record features and trouble-free synchronous motor drive. The Sony 521. Here are sensitive level meters and split-second stop lever, assuring true fidelity, precise cueing and editing. The Sony 521.

- * $7\frac{1}{2}$ + $3\frac{1}{2}$ tape speeds
- * tape index indicator
- * instant stereo/mono switch
- * tone control
- * automatic cut-off
- * additional line outlet
- * headphone monitor jack
- * professional mixing

124 gns. including 2 dynamic microphones and all accessories

SONY® **RESEARCH MAKES THE DIFFERENCE**

Detailed specifications on the range of Sony tape recorders are available from the

Sole U.K. Distributors: **TELLUX LIMITED** 44 BRUNEL ROAD, ACTON, W.3. Tel: SHE 0331
A member of the K.G. (Holdings) Group of Companies

SEND YOUR ORDER NOW!

for
TAPE RECORDING YEARBOOK
1962-63

Designed to cater specifically for the ever-growing circle of tape recording enthusiasts, the fifth and latest edition of the **TAPE RECORDING YEARBOOK** is now ready. The first copies of this unique reference book recently came off the press. If you want to be certain of getting your copy fill in and return the form below **NOW**.

Once again the "at-a-glance" comparison charts have been included. This tabulated form of presenting specifications and prices of equipment has proved most popular in past numbers. This edition contains catalogues for all

the current tape recorders, microphones, and mixer units, together with illustrations.

Other contents are listed below, and the useful speed and frequency charts are once again included.



Orders for the Yearbook will be dealt with in strict rotation. In previous years many were disappointed when the book was sold out within weeks of the publication date. Be sure you are not unlucky this year by returning the form below together with the 7s. 6d. (post free), and ensure immediate delivery.

THE CONTENTS INCLUDE

★ The only available up-to-date catalogue of every tape recorder and microphone on the market, with full specifications, prices, etc., and photographs.

★ A full review of tape developments during the past year.

★ Advice on choosing—and using—a tape recorder.

★ Tape and cine.

★ The law of copyright.

★ Tape records.

★ Tape recording clubs.

★ Full directory of tape clubs, manufacturers.

SIMPLY PRESENTED IN NON-TECHNICAL LANGUAGE

FULLY ILLUSTRATED

PRICE - 7s. 6d. (inc. postage)

POST NOW to: 7, Tudor Street, E.C.4

Please send me.....copy(ies) of Tape Recording Yearbook 1962-63 at 7s. 6d. a copy (including postage), I enclose remittance herewith.

Name

Address.....

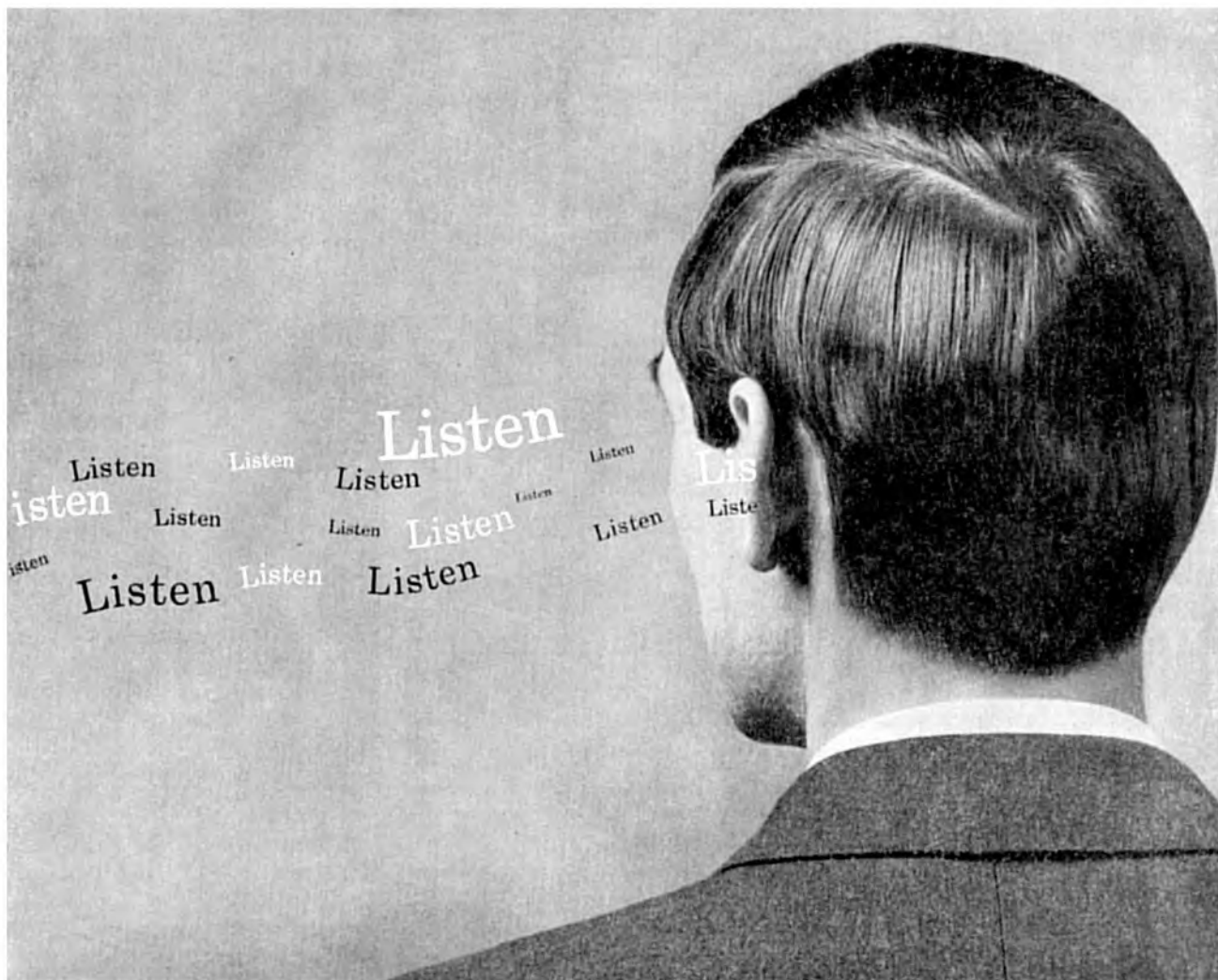

a word in your input

Let's get back to nature a bit. Ears came before loudspeakers. Senses came before specifications. And in the gamesmanship of audio jargon let's not forget that *recorders are for listening to*. ■ The ultimate test of a tape recorder rests with your *senses*. You can appreciate a fine, true sound *when you hear it*. You can recognise efficient, no-nonsense styling *when you see it*. You can sense the crisp alertness of a well-balanced mechanism *when you handle it*. ■ These subjective factors play a vital part in our thinking at Truvox. We aim to satisfy them with the *extra* quality, beyond the specification, that we engineer into every recorder bearing our name. The result we call *The Truvox Touch*. ■ The new *Truvox 60* has every facility for the most exacting recordist. We make it in two versions (R62—twin-track, 3½ and 1½ ips, and R64—four-track, 7½ and 3½ ips). Frequency response 40—14,000 at 7½ ips, signal to noise—40 dB, wow and flutter better than .25%, full mixing, superimposing and monitoring, auto-stop, pause control, 4-digit counter, 4 watt output, 7" reels. Supplied with mic., 7" reel of tape, recording lead . . . and all for 39 gns. either model!



THE TRUVOX TOUCH

R62 twin-track (3½ and 1½ ips)
R64 four-track (7½ and 3½ ips)

39
gns

complete with microphone, 7" reel of tape and recording lead.

Send now for leaflets showing *all* the tape recording equipment with The Truvox Touch:—

TRUVOX LTD., Neasden Lane, London, N.W.10

starts where the specification leaves off

WORLD RECORD CLUB OFFERS YOU THE CHOICE OF ANY 3 PRE-RECORDED TAPES



31. Rimsky-Korsakov: Scheherazade. Sir Eugene Goossens conducts the LSO in a breathtaking performance of this rich and exotic masterpiece. Also on disc: mono/stereo



32. Star cast and orchestra stage all the famous songs: Getting to Know You, Hello Young Lovers, I Whistle a Happy Tune, Shall We Dance, etc. Also on disc: mono/stereo



53. These two suites, containing some of Bizet's most thrilling music, are given magnificent performances by the Sinfonia of London under Muir Mathieson. Also on disc: mono/stereo



19. Look Over Your Shoulder, My Lean Baby, White Christmas, Don't Worry About Me, Melody of Love. 12 top numbers sung by the fabulous Sinatra. Also on disc: mono only



56. All the magic of old Vienna! starring Jacqueline Delman, John Larsen, Linden Singers and Sinfonia of London conducted by John Hollingsworth. Also on disc: mono/stereo



33. Beethoven 5th, plus Egmont, Josef Krips and LSO in a titanic interpretation which matches the tremendous power of this celebrated music. Also on disc: mono/stereo



30. Ian Carmichael, Joyce Blair, star cast/orchestra. As Long as He Needs Me, Consider Yourself, all the hit numbers from Lionel Bart's great show. Also on disc: mono/stereo



39. Great ballet conductor John Hollingsworth and the Sinfonia of London in a sparklingly fresh interpretation of Tchaikovsky's famous Ballet. Also on disc: mono/stereo



20. Answer Me, Nature Boy, Ruby and the Pearl, these plus 8 more favourites sung especially for you by the unique Nat King Cole. Also on disc: mono only



40. Superb singing by Bruna Rizzoli and Giuseppe Savio with the chorus of the Teatro Nuovo di Milano and orchestra conducted by Napoleone Annovazzi. Also on disc: mono only



29. Me and My Shadow, Among My Souvenirs, Mean to Me, How About Me... the fabulous Judy Garland sings 11 of her greatest songs. Also on disc: mono only



25. Ian Wallace, Joyce Blair and chorus. Some Enchanted Evening, I'm In Love With a Wonderful Guy, and all the unforgettable songs from this great musical. Also on disc: mono/stereo



34. Stardust, How High the Moon, Nearness of You, 'Round Midnight, King David—eight numbers by the vibraphone genius, Lionel Hampton. Also on disc: mono/stereo



48. Deep in My Heart, Drinking Song, Serenade—all the old favourites fresher than ever with Marion Grimaldi, Linden Singers and Orchestra. Also on disc: mono/stereo



37. Revolutionary Study, Polonaises A and A flat, Fantaisie-Impromptu—12 favourites in all played by the pianist of Dirk Bogarde's 'Song Without End'. Also on disc: mono only



22. 12th St. Rag, Isle of Capri, Smile, Blue Moon, Bunny Hop Mambo, Satin Doll. 12 top numbers played in characteristic style by the Duke and his band. Also on disc: mono only



2. Grieg Piano Concerto. Alexander Jenner in an electrifying performance with the Bavarian State Radio Orchestra conducted by Odd Gruner-Hegge. Also on disc: mono only



35. O! Man River, Bill, Make Believe, many more well-loved numbers from this famous musical memorably sung and played by full star cast. Also on disc: mono/stereo



44. Leopold Ludwig and LSO combine brilliantly in an exciting 'double': two of the world's greatest symphonies receive vivid new interpretations. Also on disc: mono/stereo

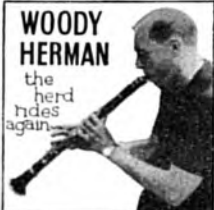

45. Crazy Rhythm, Bijou, I Cover the Waterfront, Northwest Passage, Blowin' Up a Storm, etc. The master clarinetist plays 12 numbers in great style. Also on disc: mono/stereo



38. Hervey Alan, Ian Wallace, Marion Grimaldi and chorus sing the immortal favourites: Cobbler's Song, Robbers' Chorus, Chu Chin Chow, etc. Also on disc: mono/stereo

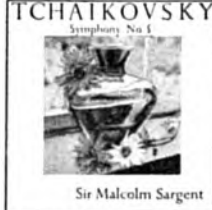

14. Tchaikovsky Symphony No. 5. Sir Malcolm Sargent and LSO combine to give this famous symphony a dramatic and colourful rendering. Also on disc: mono/stereo



43. Andy Cole, Barbara Leigh, Mike Sammes singers: High Society, Three Coins, Harry Lime, Gigi, The High and the Mighty, 11 top film hits. Also on disc: mono/stereo

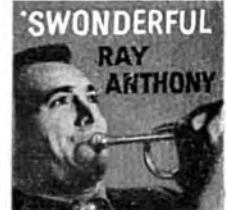

41. Night and Day, King Porter Stomp, Pennies from Heaven, Christopher Columbus, Don't Be That Way, with the top American bandleader/trumpeter. Also on disc: mono only



42. Jericho, Swing Low, Shadrak... 12 of the best loved Negro Spirituals movingly sung by George Brown, Isabelle Lucas and Linden Singers. Also on disc: mono/stereo



36. Beale Street Blues, After You've Gone, The Sheik of Araby, My Kind of Love, 12 tremendous hits by one of the world's greatest jazz trombonists. Also on disc: mono only



49. Beethoven's Fidelio Overture, Brahms' St. Anthony Vars, Mendelssohn's Hebrides, Wagner's Siegfried Idyll. All under Britain's greatest young conductor. Also on disc: mono/stereo



50. David Hughes, Barbara Leigh, Andy Cole and chorus sing Indian Love Call, Rose Marie, and all the other tunes from Friml's well-loved musical. Also on disc: mono/stereo



47. Brahms Violin Concerto. Superb playing by Endre Wolf and Sinfonia of London under the baton of Anthony Collins makes this a truly memorable performance. Also on disc: mono/stereo



46. Elizabeth Larner, Andy Cole, Peter Knight singers. Exciting 'double' featuring highlights from two famous shows by Frederick Loewe and Cole Porter. Also on disc: mono/stereo

FOR ONLY 30/-

THE GREATEST BREAKTHROUGH SINCE TAPE RECORDING!

Here is the greatest World Record Club introductory offer ever made . . . a unique offer never before matched by any record club or company anywhere in the world!

EVERY ONE OF WORLD RECORD CLUB'S UNRIVALLED RELEASES AS 12" LPs IS NOW AVAILABLE ON 3 3/4 ips TAPE!

Now you have the opportunity to play any WRC release on your tape recorder. Each of these 'tape records' runs at 3 3/4 ips, mono, on 5" spools and can be played on either 2 or 4 track recorders. New electronic techniques of tape-to-tape transfer give these 3 3/4 ips WRC pre-recorded tapes a standard of reproduction unattainable previously at less than 7 1/2 ips.

WORLD RECORD CLUB 7-POINT PLAN MEANS BETTER LISTENING FOR YOU!

1. AN UNPARALLELED INTRODUCTORY OFFER.

Choose now, any three of the superb 3 3/4 ips pre-recorded tapes shown here, for only 10/- each and number them on the attached coupon. (If you wish, of course, you can choose 12" LPs instead. Both disc and tape are the same price.) Please send no money until after you have received, played and approved them. We want you to prove to yourself, before paying, that our tapes are equal to the world's best.

2. THE OPPORTUNITY TO BUILD A UNIQUE TAPE COLLECTION.

The WRC plan offers you an exciting and varied annual repertoire of more than 60 selected tape releases, covering classics, jazz, shows, ballet music, light music and 'pops'. Every one is a superlatively recorded 3 3/4 ips mono tape (or 12" LP—mono and stereo). Each is offered to you at the

privilege club price of 29/- (plus a small charge for post and packing)—much less than you would pay elsewhere for recordings of anything like this quality. Your only obligation, as a Club member, is to agree to buy four more tapes (or 12" LPs) over the year. Beyond this, there is no subscription or membership fee.

3. A PLANNED PROGRAMME.

Every World Record Club release is hand-picked by an independent panel of Britain's top musical authorities. The Countess of Harewood, Lord Montagu of Beaulieu, Sir Arthur Bliss, Richard Attenborough, Cyril Ornadel, Ray Ellington, Leon Goossens, Malcolm Arnold, Steve Race, John Hollingsworth, Antony Hopkins—and, as special adviser on tape, Miles Henslow.

4. FREE MONTHLY MAGAZINE.

A monthly magazine, packed with fascinating musical articles, reviews, news and pictures, is issued free to all members.

5. SPECIAL CONCERT PRICE CONCESSIONS.

Many concert halls and theatres throughout the country (including the Royal Festival Hall) allow special concession rates to club members for many performances.

6. FREE BONUS TAPES.

The more you buy, the more you save! After fulfilling the minimum membership obligations, you earn another tape of your own choice free for every extra three you buy!

7. EXCLUSIVE EXTRA RELEASES.

In addition to the regular monthly selections, the club offers members exclusive extra tapes at the standard Club price.

World Record Club is unique—the first and greatest Record and Tape Club in Britain, with the largest show catalogue (on tape and mono/stereo disc) in the world. No other method of tape—or record-buying offers you so many additional benefits, so much freedom and variety of choice, with no 'high-pressure' selling. And, of course, there are no subscriptions or membership fees of any kind—only a small deposit of £1 (later refundable) when you become a tape member.

Don't miss this great opportunity. Send off the coupon today, for your 3 introductory selections for only 30/-



... AND IF YOU OWN A
STEREO TAPE RECORDER
hear the fantastic reproduction of
STEREO 21
THE NEWEST,
TRUEST SOUND
ON TAPE TODAY!

Revolutionary new STEREO 21 pre-recorded tapes (7 1/2 ips twin-track) are issued exclusively by World Record Club. But they are offered without membership commitments of any kind. The first list of all new STEREO 21 releases is now available. It features 30 superb stereophonic tapes ranging from Beethoven's Eroica with Josef Krips conducting the LSO, to a lavish full-cast production of Oklahoma.

As always, WRC prices present unparalleled value—all STEREO 21 releases cost either 50/- or 60/- depending on playing time (up to 50 minutes). STEREO 21 tapes are now obtainable through leading retailers or direct by post from World Record Club. Send for full catalogue now—STEREO 21 must be heard to be believed!

7-DAY FREE TRIAL OFFER—POST TODAY!

STEREO 21 FREE BROCHURE

To WORLD RECORD CLUB (Dept. TRG3) Box 11
PARKBRIDGE HOUSE, RICHMOND, SURREY.

SEND NO MONEY NOW

3 3/4 ips pre-recorded tapes	12" LPs
------------------------------------	---------

Tick which you want

Please send me, without obligation, on 7-day free trial, the three selections indicated. (Your 3 selections must be either all tape or all disc.) If satisfied, I will pay you 30/- plus 3/- postage, packing and insurance. Only at that stage may you enrol me as a full member of World Record Club, entitled to all the benefits described. My only obligation as a member would be to agree to purchase 4 more top quality 3 3/4 ips tapes (or 12" LPs) over a 12-month period at the special club price of 29/- each. If I am not completely satisfied with my 3 selections, I will return them to you within 7 days, in good condition, and owe you nothing.

NOTE I understand I will be asked to pay £1 deposit when I become a tape member (this does not apply to disc members). This deposit is refundable.

Signed.....
this offer applies in Gt. Britain and N. Ireland only.

MY 3-SELECTION 'PACKAGE' COMPRISES

Choice No. 1 Choice No. 2 Choice No. 3



(place tape/disc key numbers only in the circles)

Tick here if stereo 12" LPs are required where available

Mr/Mrs/Miss
(BLOCK CAPITALS PLEASE)

ADDRESS

To WORLD RECORD CLUB (Dept. TRG3)
Box 11 PARKBRIDGE HOUSE, RICHMOND, SURREY.

Please send me your free colour brochure, showing the full range of your new STEREO 21 releases.

NAME

ADDRESS

New tape (T42) from W.R.C.: Tauno Hannikainen conducts Sinfonia of London in Sibelius Symphony No. 5

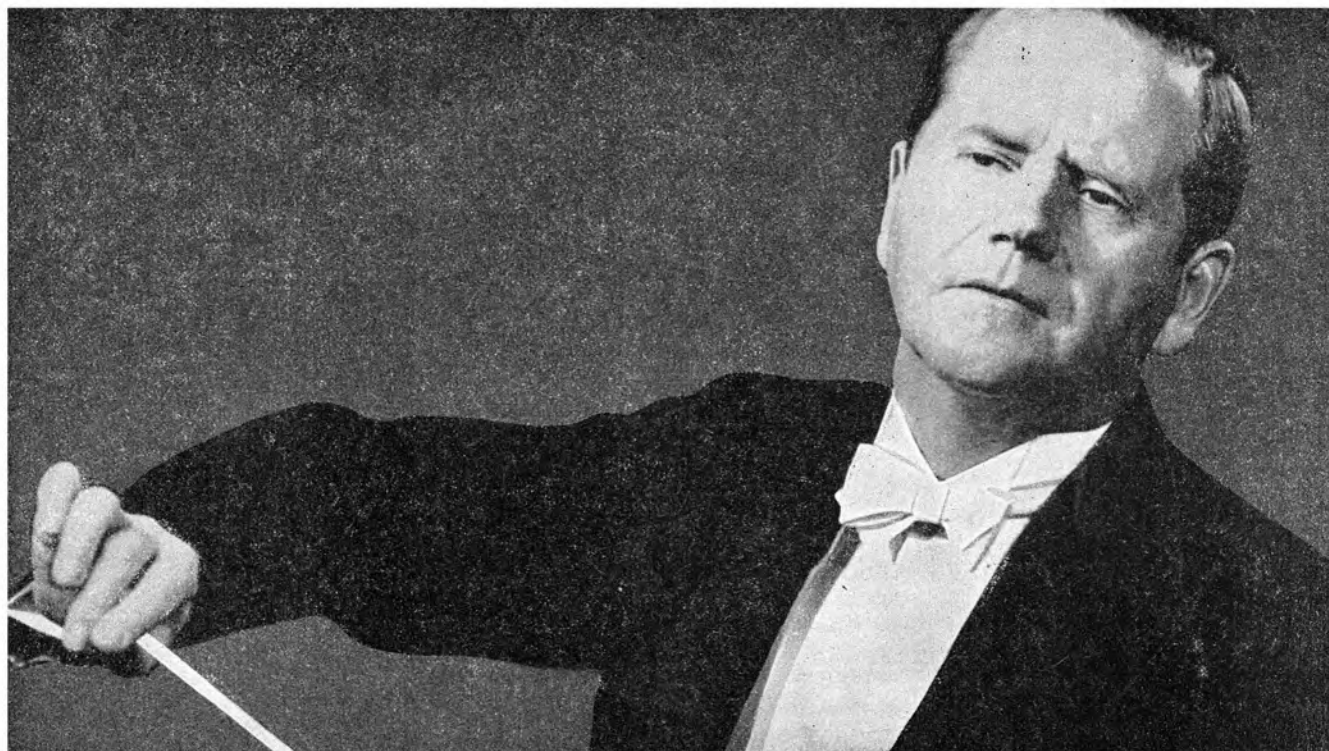

The
World Record Club
uses Emitape
for all its
tape records *(Emitape gives
as good as it gets)*

Emitape

E.M.I. TAPE LIMITED · HAYES · MIDDLESEX · HAYES 3888

Million-pound Studio or Twenty-pound Mike ?



D 19 B



D 25



BC 30 A

■ A million pounds might buy you an acoustically-perfect recording studio, free of low frequency reverberation.

■ Twenty pounds will buy an AKG cardioid microphone that does the same job—retains its directional selectivity clear down into the bass and makes even a “live” living room a recording studio.

Of all microphone makers, AKG of Vienna has the basic patents on dynamic mikes with full-range cardioid response—the characteristic that alone makes this possible. AKG’s cardioids are cardioid where you need it most.

This is only one of the plus values in an AKG. They are all rugged . . . smooth in their translation of sound . . . built with care and old-world craftsmanship.

From von Karajan to Joe Doakes, AKG is first choice for crisp, full-bodied sound. From £100 to £7, AKG cardioids are the cardioidest mikes you can buy today.

All enquiries to:

POLITECHNA (LONDON) LTD.
3 PERCY STREET - - LONDON W.1

Telephone: LANGHAM 6236 Telex: 23894
Cables: POLINDUST LONDON

Amalgamated Wireless (Australasia) Ltd., Sydney,
Wellington—Soundrite Ltd., Singapore, Penang, Kuala
Lumpur—Hind Industrial & Mercantile Private Ltd.,
Bombay—China Engineers Ltd., Hong Kong—
Sandbach, Parker & Co. Ltd., Georgetown—Inter-
national Aeradio (East Africa) Ltd., Nairobi.



TAPE RECORDING MAGAZINE

Vol. 6

No. 10

October 1962

IN THIS ISSUE

BRITISH AMATEUR TAPE RECORDING CONTEST 1962	15
<i>The presentation of prizes</i>	
The Radio Show	19
Service Bureau	20
Harry Mack	
Interviewing	22
Alec Nisbett	
Tape Records reviewed	25
Don Wedge and Ted Greenfield	
Tape Recording Simplified	28
Robert Hirst	
Test Bench	30
Grundig TK40	
New Products	32
Letters to the Editor	35
News from the clubs	36
Tape Exchanges	40

COVER PHOTOGRAPH: An electronics engineer adjusts the recording level indicator of a Revox E.36 stereophonic tape recorder in our illustration this month. The large machine on the right-hand side of the engineer enables him to check both channels simultaneously. The Revox recorders, manufactured in Zurich, Switzerland, have recently been made available for sale in this country, and are available from Audiocraft Ltd. of London.

“TAPE Recording Magazine” is published on the third Wednesday in the month, by Print and Press Services Ltd., from 7, Tudor Street, London, E.C.4.

“TAPE Recording Magazine” is available by a postal subscription of 20s. per annum including postage, or it can be obtained at newsagents, bookstalls and radio and music dealers. In the event of difficulty, write to the Publishers at 7 Tudor Street, London, E.C.4.

Back numbers, if still in print, are available at 2s. 6d. per copy for issues up to November 1959, and 2s. per copy for later numbers.

Address all communications

7 TUDOR STREET, LONDON, E.C.4

FLE 1455

EDITORIAL

ADVERTISING

Editor,

R. DOUGLAS BROWN

Assistant Editor, FRED CHANDLER

Advertisement Manager,
MISS PAMELA DURHAM

THE EDITORIAL VIEW

THE Contest celebrations went off very enjoyably; it was pleasant to meet several former winners returning to collect new honours and encouraging to make the acquaintance of newcomers to the ranks of honour.

One view they all seemed to hold, and it has been noted by the Contest organisers. Most competitors, it is clear, would like to hear a selection of the winning tapes and some detailed explanations of why they were selected as the best.

This has been a problem for the Contest organisers from the outset. In the first three years there were public playbacks of the winning tapes. There seemed some doubt, however, whether these functions were generally desired and last year, as an experiment, it was resolved to issue, instead, a special Contest tape containing the winning entries in the British and International Contests. Unfortunately, delay in securing copies of the Continental tapes wrecked this good intention.

Before next year the whole situation will be studied afresh. Meanwhile, however, the Federation of British Tape Recording Clubs, noting the views expressed by this year's competitors, has arranged to make available copies of all the winning entries. Clubs affiliated to the Federation may borrow these copies without charge.

Other clubs and individuals may hire them for a very modest charge.

Full information may be obtained from the Federation Secretary, Roger Aslin, 211, Melfort Road, Thornton Heath, Surrey.

* * *

WHILE I am writing of the Federation, perhaps I may get in a word of praise, albeit belatedly, for the new Federation Bulletin. The cover is very striking and the duplicated Bulletin within is full of useful information, including the list of dealers who have applied to go on a Federation "approved list."

* * *

ONE of the international tape-spondence clubs, "World Wide Tape Talk," is organising a petition in Britain. They are collecting signatures to urge the Postmaster-General to reduce the charges for sending tape messages by air mail.

They point out that air mail charges to Australia and New Zealand are high and surface mail is too slow to encourage tape-spondence.

I wish them luck.

* * *

DO you insure your tape recorder? I suspect that most people do not, but the risk, particularly if you take your recorder around with you, is out of all proportion to the modest premiums called for.

I quote from a new scheme announced by Telesurance Ltd. A "limited policy," covering fire, theft and accidental damage, costs as little as ten shillings.

A "comprehensive policy," covering these risks, plus maintenance, costs £3 for recorders costing under £60, and £5 for those costing between £60 and £105.

I shall watch with interest this effort to persuade enthusiasts to provide proper cover.

* * *

SIR HAROLD BISHOP, Director of Engineering at the B.B.C., gave us some additional information on stereo radio prospects in a letter to the *Guardian* recently.

The B.B.C., he revealed, is just beginning experimental transmissions from the Wrotham VHF station using the Zenith-G.E. system which has been adopted for stereo broadcasting in the U.S.A. and which the European Broadcasting Union favours as the system for Europe.

The results of these and other European experimental broadcasts will be considered when the CCIR meets in January next year.

LAUGH WITH JEEVES

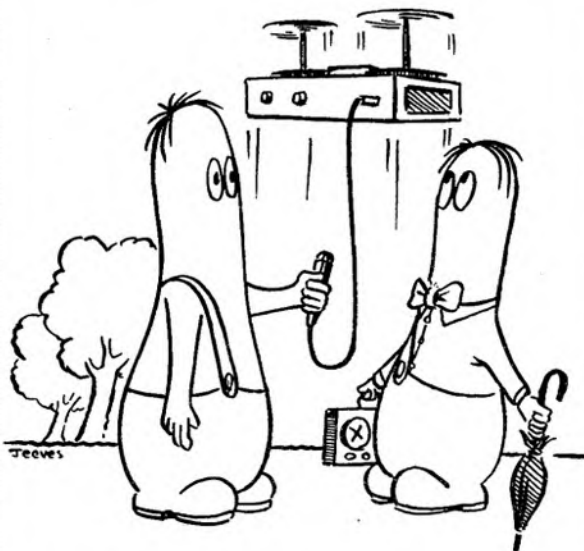

"I got tired of carrying it, so I extended the shafts and fitted propellers on 'em"



THE CONTEST WINNERS

The 1962 British Tape Recording Contest reached its climax with two memorable social events in London's West End—the Emitape Luncheon at the Savoy Hotel and the party given by TAPE Recording Magazine at the Cafe Royal.

All the winners, except Mr. P. L. Bastin, were present and exchanged experiences and discussed their tapes with the judges.

At the Savoy the Emitape Cup was presented to Mike Avel, representing the Triumph Owners' Motor-cycle Club, by Mrs. Wall, wife of the Managing Director of E.M.I. Ltd. Mr. J. E. Wall presided, and proposed a toast to the guests, for whom Miss Jo Douglas replied.

At the evening event at the Cafe Royal, the Editor of the magazine handed the awards to the various winners.

Between the two events the prize-winners visited the Radio Show at Earls Court.

The prize winners are seen together at the Cafe Royal in the photograph above. They are, reading from left to right: front row, H. J. Walding (Grundig Cup), Miss A. M. Goodwin (Acos Cup), Ronald P. Guttridge (Irish Trophy and Wyndor Gold Medal), Mike Avel (Emitape Cup); back row, Reginald Bonney, Gerry Fitzgerald, F. C. Gazeley, the Editor of TAPE Recording Magazine, Roger Gomes and David Peach (Amphlett Shield). Peter L. Bastin, the remaining prizewinner, was unable to be present.

HOW TO MAKE THE TAPE OF THE YEAR—In the picture below Mike Avel appears to be telling the Editor the secret of success.

Photographs of the Savoy lunch are on page 17.



The "Tape of the Year" was recorded on Ferrograph

It is with pleasure that we tender our congratulations to the three Ferrograph users who, in the British Amateur Tape Recording Contest of 1962, secured five of the six major awards. They are Mr. Michael Avel on behalf of the tape section of the Triumph Owners' Motor Cycle Club who won the Emitape Challenge Cup and the Amphlett Shield for "The Tape of the Year"; Miss A. M. Goodwin who was awarded the Acos Challenge Cup and Mr. Ronald P. Guttridge who secured the Irish Trophy and the Wyndors Gold Medal.



Series 4A

For conventional Monaural Recording and Playback.
Model 4A/N (3 $\frac{3}{4}$ /7 $\frac{1}{2}$ i.p.s.) **81 GNS**
Model 4A/H (7 $\frac{1}{2}$ /15 i.p.s.) **86 GNS**

That Ferrographs should have played a part in securing so high a proportion of the major awards is indeed gratifying, but not entirely unexpected. For, as we have stated on more than one occasion, all our energies over a period of fourteen years have been concentrated on a single purpose—the attainment of the highest possible standard of fidelity in Tape Recording.

In the making of an outstanding tape, as every serious recordist is aware, three factors are involved, namely, the basic idea, the development of that idea in terms of sound and, finally, the actual recording. It is clear that in the Contest to which we refer, the basic ideas and their development reached a very high standard and as to the third factor, we content ourselves with remarking that, so far as recording quality is concerned, the Ferrograph spoke for itself!

Series 5

Monaural recording and reproduction.
Model 5A/N (3 $\frac{3}{4}$ /7 $\frac{1}{2}$ i.p.s.) **85 GNS**

Series 4S

As above but in addition fitted with stereo head to permit playback of pre-recorded stereo tapes through external hi-fi amplifiers and loudspeakers.
Model 4S/N (3 $\frac{3}{4}$ /7 $\frac{1}{2}$ i.p.s.) **88 GNS**
Model 4S/H (7 $\frac{1}{2}$ /15 i.p.s.) **93 GNS**

Series 420

For Monaural and Stereo recording and playback, with monitoring, re-recording from one track to the other, introduction of echo effects and many other advanced features. Requires power amplifiers and external loudspeakers.
110 GNS

Three Independent Motors · Recording Level Meter · Brief Stop · Switched Speed Change with Compensated Correction Network · Separate Tone Controls · Uses 8 $\frac{1}{4}$ " Tape Spools · Gear Driven Turns Counter · Automatic Switch cuts Motors at end of Spool · Endless Loop Cassette (Optional Extra)

The Incomparable **Ferrograph**

THE FERROGRAPH COMPANY LTD.

84, BLACKFRIARS ROAD, LONDON, S.E.1

Telephone: WATERloo 1981

AT THE SAVOY

The photographs on this page were taken at the Emitape Luncheon at the Savoy Hotel. On the right Mrs. J. E. Wall is joining in a traditional ceremony at this event—drinking champagne from the Emitape Cup as it is passed around the table. In the other photographs, left to right, moving down the page are: (1) Mike Avel talking to Mr. J. E. Wall, the Managing Director of E.M.I. Ltd; (2) John Borwick, one of the judges, with Mr. and Mrs. F. C. Gazeley; (3) Mrs. Wall with Mr. and Mrs. Bonney; (4) Jo Douglas and Alan Stableford, who were both judges; (5) A composite photograph of some of the guests at table.





ONLY A PILLAR-BOX AWAY!

Wherever you live, you are only a 3d. stamp away from the biggest Specialists in the Country! We *guarantee* our terms—which include **NO INTEREST CHARGES**—cannot be beaten.

Thinking of buying a Tape Recorder? Interested in saving money? Then write or phone us today for Free Brochures on all the best makes and Full Details of our Amazing Offers:

HOWARD

**218 HIGH STREET,
BROMLEY, KENT**

RAVensbourne 4000/4477

Fred Chandler spots the new recorders shown at

THE RADIO SHOW

THE 1962 Radio Show exhibition at London's Earls Court was designed on the theme "The Fair of the Air," and it was just that. Although near the entrance to the main hall the visitor found himself first of all alongside an audio avenue, this section was soon passed and one became lost in a maze of television and radio receivers.

Apart from the larger companies like Bush, Ekco, Ferguson, Ferranti, and Murphy, whose tape recording activities are but a small percentage of their overall production line, one could visit Alba, B.R.C., Clarke & Smith, Dansette (entering the tape field for the first time), Dynatron, E.A.R., E.M.I., Elpico, Fidelity Radio, Philips, Portogram, Tape Recorders (Electronics), and Garrard.

Perhaps the most interesting of the products seen were the new machines presented by Dynatron, Clarke & Smith, and Philips.

THE new Dynatron machine, designated TRP2, is not yet in full production. The prototype shown is close to professional standards, and will be available in two and four-track versions, mono only.

It incorporates a meter recording level indicator, and clock counter, auto and instant stop controls, plus built-in echo effect facilities. Good sound reproduction is claimed from the 10 x 6 inch speaker unit.

Fuller specifications, including the price (around £120), will be published when available.

THE Clarke & Smith stand presented two new recorders, the 634 and 635. Both machines are housed in strong wooden cases fitted with locks and two carrying handles to enable two persons to carry the machines if necessary.

The 634 is described as a professional machine of particularly high performance. The elegant appearance is seen in our illustration right, which shows the Wearite deck incorporated.

It features two completely separate transistorised amplifiers for record and replay, with mixing and monitoring facilities provided. Other features include automatic frequency correction if a speed change is made, a built-in 9 x 5 inch elliptical speaker unit, straight-through amplification mode, superimposition and meter recording level indicator.

The tape speeds are $7\frac{1}{2}$ and $3\frac{3}{4}$ ips with a quoted frequency response of 50-15,000 cps \pm 3 dB at $7\frac{1}{2}$ ips, and 50-9,000 cps at $3\frac{3}{4}$ ips.

Three input and three output sockets are provided. Other features include an automatic tape end stop switch, pause control, digital rev. counter, three heads, and accommodation for $8\frac{1}{4}$ -inch spools. Rewind speed for 1,750 ft. of tape is given as less than one minute.

The Type 635 has specifications identical to the Wearite model, but features a Truvox deck. Push-button operation is provided on this model, plus an interlock feature when the machine is in the "record" mode. Three motors, balanced heavy flywheel, separate precision ground drive pulleys for each speed, and disengaged in the "off" position are additional features.

Delivery for either model is not expected until mid-October, by which time we hope to have a model for review. The price of the TR634 is 103 guineas, and the 635 costs 86 guineas.

THIRD of the higher-priced models, for the first time, was shown on the Philips stand.

This is the 92-guinea EL3534 four-speed stereo tape recorder which replaces the model EL3536. Eight hours play with a seven-inch reel of double-play tape are provided using the ultra-slow speed of $15/16$ th ips.

Among the many features are facilities for monitoring, and mixing, automatic tape and stop, inputs for microphone radio and pick-up, and provision for straight-through amplification for mono and stereo: outputs for extension loudspeaker, headphones, or radio sets are also provided.

One unique feature is the provision for "Multiplay." This enables the production of several sounds after each other, combining them on one sound-track, and reproducing them all together.

An all-transistor amplifier is incorporated, allowing instant use without the need for the usual warming-up process and preventing any over-heating of the machine.

Two 7 x 5 inch elliptical loudspeakers are included, providing an output of three watts per channel.

Housed in a wooden cabinet covered with P.V.C. foil, and with a detachable lid, the EL3534 measures $18\frac{1}{2}$ x 15 x $8\frac{1}{2}$ inches and weighs 43 lbs.

FERRANTI introduced a new model this year, a four-track version of the model TR1044 which was shown last year for the first time. The new model is the RT1069, illustrated on this page.

A B.S.R. Type TD2 deck with a single speed of $3\frac{3}{4}$ ips is incorporated. This will accommodate $5\frac{1}{4}$ -inch spools, providing a playing time of 45 minutes per track using standard-play tape.

(Continued on page 21)



CLARKE AND SMITH
MODEL 634
Wearite deck

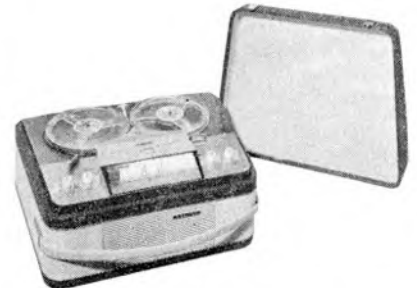

PHILIPS EL3534
Unique "Multi-play"



FERRANTI RT1069
Four-track model

'BELTING UP'

AS my rather impolite title indicates, we have won enough space to allow a discussion of that vexing problem, the broken or slipping belt.

It seems, from a quick perusal of the mailbag, that this is a matter that worries a fair number of readers—and this is surprising. In the average service engineer's day, belt trouble is not the most frequent fault encountered. Although, on some machines, it can be one of the most awkward.

This may be because many of our customers are not so well versed in the "running repairs" of their tape recorders as are readers of *TAPE Recording Magazine*. They bring or send their machines for such trivia as dirty heads, twisted tapes or pressure pad adjustment.

For the same reason, the preponderance of "belt queries" in our postbag may be due to the deterring sight of the underside of one's deck rather than the frequency with which these faults occur. So, for the benefit of several unfortunates who have experienced a breakdown and can't see for the life of 'em how the darn things are put on (I paraphrase), let us study a few belt layout diagrams and unravel a few of their secrets.

Walter 303 DeLuxe. *First call to Mr. J. P. R. of Tavistock, who has obtained a new belt for his Walter 303 and cannot see how to fit it without a full-scale dismantling operation.*

I sympathise with you, J. P. R.—and congratulate you also, on obtaining a spare part that is now becoming difficult to order. At first sight, the Walter deck does look as if the designer did not intend that the belt should ever be replaced. But there is a fairly easy method, once you know it. And the secret is—a buttonhook!

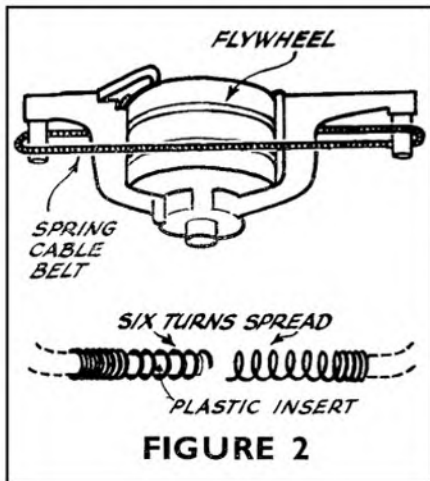

FIGURE 2

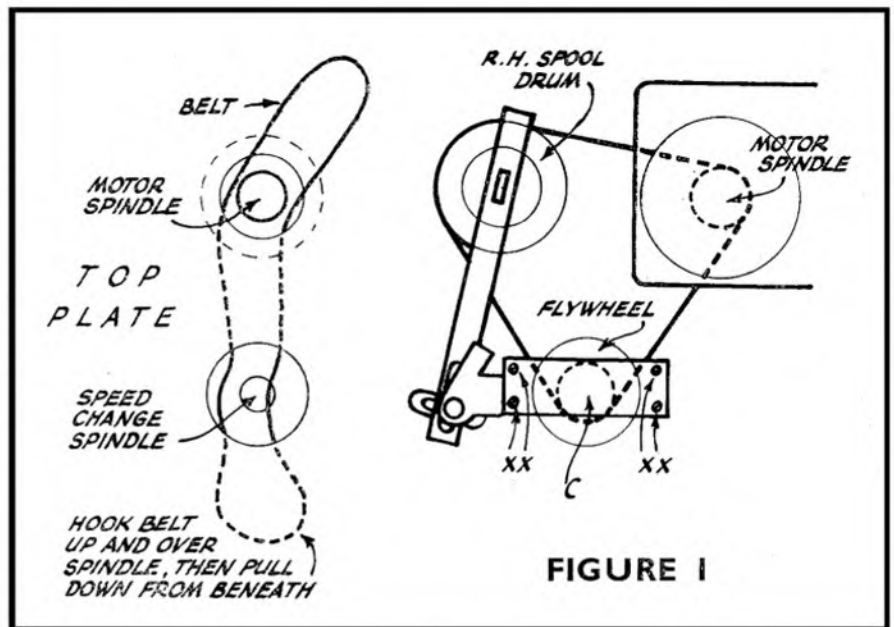

FIGURE 1

This handy instrument is used to hook the belt up through the speed-change knob clearance hole in the top of the deck and over the spindle. Referring to Fig. 1, the complete procedure is as follows:

(a) With machine disconnected, switch to "Fast Reverse" and $3\frac{1}{2}$ ips. Remove spools, knobs, top-plate, and bottom.

(b) Insert new belt through motor spindle hole, draw it through speed-change knob clearance hole and lift over spindle. Allow belt to sit around top groove of motor pulley and take up slack from bottom of machine. N.B.: a small piece of Sellotape will hold the belt in place around the motor pulley temporarily. Don't forget to remove it when the operation is completed.

(c) Turn machine on face. Remove the four screws (X) that secure the flywheel assembly and the capstan bracket (C).

(d) Withdraw flywheel, and fit belt. During this move, take care that the capstan spindle is not strained and that the joystick does not foul the setting plates or levers. Gently does it!

(e) Reassemble flywheel and capstan bracket and feed belt between the end of the clutch spindle of the right-hand drum (left-hand in diagram—machine inverted) and the phosphor-bronze spring on the lever. In the "Fast Reverse" function there should be just enough clearance for this. Let the belt settle around the drum.

(f) Tighten the capstan bracket, ensuring that the flywheel is free in its bearing, remove the piece of Sellotape and you are ready to go.

Points to observe, also applicable to all belt jobs, whether plastic, rubber or spring, are not to stretch unduly and to avoid grease and oil being transferred to the belt from flywheel bearings, etc.

Philips AG8107. *Mention of spring belts reminds me of W. B.'s query, from Penzance. He has a Philips AG8107 on which a new belt was recently fitted and he is now experiencing a knock that "appears to be caused by the belt joint."*

No doubt this was due to a clumsily made joint rubbing on the flywheel casting. The belt on this long-service model (released December, 1956, and still going strong) is a long coiled spring, threaded in the manner of Fig. 2, and joined by what can best be described as a "spiral splice."

The secret is to slightly open the last six turns of each end of the spring, insert the plastic guide piece into one end, unscrew the other end against the torsion of the spring and allow it to screw itself turn for turn over the guide piece. The final result is six interwoven turns—and no lump. Care must be taken not to overstretch the spring, or squash the circular shape of the ends.

To make this joint without the bugbear of tension, simply slip the belt down to the stop-plates of the pulleys, when enough slack can be gained to work in comfort.

When threading the belt, lay the uncased machine on its back, pass the belt from left to right in the top slot of the flywheel, clockwise around the right-hand pulley, back around the other side of the flywheel in the bottom slot and anticlockwise around the left-hand pulley. Refer Fig. 2.

More advice in our

SERVICE BUREAU

by Harry Mack

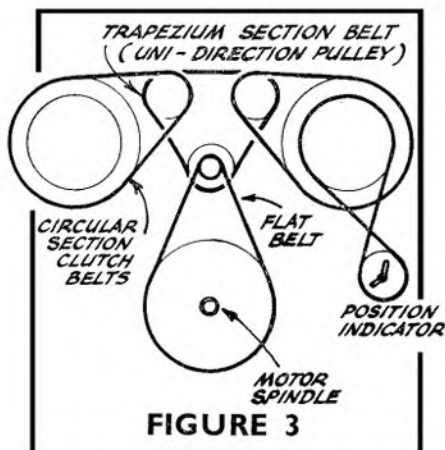

No doubt, W. B. will find that the joint has to be made. The great advantage of this cable spring type of drive is that it can be stretched overall. Thus, a half-inch can be cut off the end to make a fresh joint and the extra tension will be absorbed by the stretch in the belt.

Grundig TK9 and TK12. From Clapham comes a plea for information on the Grundig belt system as used in the TK9 machine, one of which L.W.A. has purchased second hand.

Not much information was given by L. W. A. in his letter, but it is strongly suspected that this machine lay in disuse for some time and now suffers from stretched and hardened belts.

This is a common fault with belts made of thermo-plastic material, and is easily cured by the gentle application of heat. Personal method is to remove the belts altogether, let them soak in a bowl of fairly hot water, dry thoroughly, replace and run the machine for a while. Fig. 3 shows the assembly.

If the hardening is not too severe, it is possible to mould the belts back into shape and inflexibility by allowing the tape recorder to run in the "Fast Wind" position, unloaded, for an hour or so.

As for the question about "alternative belts," I presume you mean replacements from other Grundig machines, L. W. A.

The only alternative I know is the position counter belt, the 2 mm type, part No. 128/222, which is also used on the TK30, 35, 55, 60, 819, 820 and 830. I sincerely hope you do not mean the sort of thing we saw in the Grundig "Black Museum"—old garters, the tops of preserving jars and sundry elastic bands taken from machines returned to the factory for repair.

Steelman Transitate 2-711. An unusual one was reported by H. O'H., Manchester. He has an intermittent failure of take-up action.

Although this is really the subject of our last article—"Spillage"—the cause is likely to be a weak spring belt, and appropriate to our present discussion. In its worst form, both take-up and fast forward action are lost.

Replacing the belt can be a bit awkward, and care must be taken when feeding around the tightener pulleys not to stretch the spring. Fig. 4 shows the positioning of this belt. Care must be taken to ensure that the tightener pulley is quite free, that the slider bracket and its carrier lever are not binding or distorted.

When all goes well, this is an excellent little machine. But if the latter lever is clumsily handled during servicing, you are likely to have enough faults, H. O'H. to last you a fortnight.

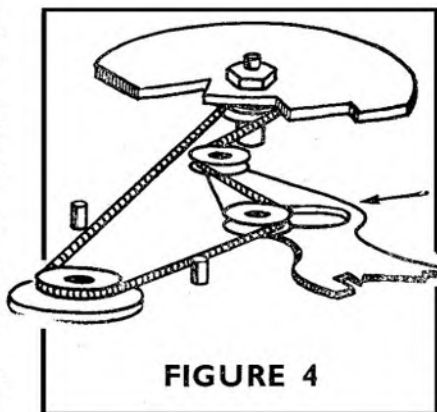

RADIO SHOW

(Continued from page 19)

Among the features is an output of 2½ watts through the built-in 7 x 4 inch speaker (3 watts for an external unit), and a magic eye recording level indicator.

An Acos Mic 40 and reel of long-play tape is included in the price of 32 guineas.

Tape Recorders (Electronics) Ltd. released eight new models at the Radio Show. Four of these represent the Slimline range of single and three-speed twin-track recorders with four-track versions of each. Their Riviera range is complemented by a new version of single and three-speed, twin-track models also with four-track versions.

Their Slimline range comprises the Three-Two recorder at 40 guineas and the Three-Four at 45 guineas. These models incorporate the Collaro Studio deck, with the speeds of 7½, 3½ and 1½ ips. Push-button operation is included together with facilities for superimposition, mixing, monitoring, and straight-through amplification.

Over 3½ watts output is claimed, and using seven-inch spools of standard-play tape a playing time of just over two hours per track is available. The four-track version also has stereo playback facilities.

Operating at 3½ ips only are the Slimline One-Two and One-Four models. These feature the B.S.R. Monardeck and are priced respectively at 32 and 37 guineas.

Again in two and four-track versions, this model provides 45 minutes' playing time per track using a 5½-inch reel of standard-play tape. Facilities are provided for loudspeakers, monitoring, mixing, superimposition and straight-through amplification. A magic eye recording level indicator, is included, and over 3½ watts output is claimed.

The Riviera range includes the two-track Sound Riviera, price 22 guineas, and the De-Luxe version, available for an extra three guineas, with four-track operation.

record it on

gevasonor

magnetic tape

GEVAERT

Ask your dealer for
free descriptive leaflet
GEVAERT LIMITED
BRENTFORD MIDDX.

INTERVIEWING

Sooner or later, every recording enthusiast tries his hand at serious interviewing. It is not as easy as it seems! Below an experienced B.B.C. producer, ALEC NISBETT, offers some practical advice.



Rather distant balance (above) may or may not be good—this depends on voice quality, background sound, etc. Indoors, it would very likely give an unpleasant boomy or resonant acoustic (using an omni-directional microphone). This balance is, on the whole, more likely to be satisfactory where the eye takes precedence over the ear—i.e. for TV.

Studio conditions (below) ensure perfection of technical quality, but will introduce a somewhat formal element into the proceedings, as the speakers sit on each side of, and probably not less than two feet from, the (bi-directional) ribbon.

(BBC Photos—Local Broadcasting Experiment)



THERE are two types of interview: the first of these is for straight news. The interviewee is at this particular moment in time uniquely able to provide the answer to the basic news questions: who, what, why, where, when, how?

The ability to ask these questions in the right order, to build a story from the headline down, is a rare skill. The newspaper reporter has the advantage that he can reconstruct his interview as he writes it, to ensure that news values as well as facts are expressed by what goes at the top of the column. The radio newsreel interviewer, on the other hand, has a "column" which is maybe 1½-3 minutes long, and he has to fill it with the right questions and the right answers, in the right order and at the right length, so that if possible no editing need be done apart from the selection of in and out cues. The interviewer must be well briefed, must have his questions ready, but must be prepared to ask "supplementaries" or follow a different line if this opens up in the course of the interview.

Another type of interview is that which goes some way beyond the basic questions of the journalist. This second type of interview is sometimes called the "interview in depth" and is intended to indicate more of the personality of the interviewee than does a simple news interview. Here some of the questioning is off the central issue and probes the background of it, so that when seen in perspective the important facts have greater meaning.

Naturally, these two types of interview overlap. However, there is a subsection of this second category which gets us well away from the orthodox news interview. This is the case where a "depth" interview is deliberately recorded at a greater length than will fit the available "spot" and is subsequently edited to length and shape. Before doing this one should, of course, ask the permission of the interviewee, but I have yet to meet anyone who has insisted on all-or-nothing. In my experience most people are very humble about their performance at the microphone and are rather relieved that a certain amount of editing will be done.

In preparing programmes for America during the last eighteen months, most of my work has been with this last sort of interview. And whereas I have not become an expert interviewer myself (far from it) I

have learned enough to know where this sort of work can go wrong and to brief the interviewers who work with me.

WHY INTERVIEW?

The first thing to do is to decide on the aim of the finished programme. Is it to discuss a particular idea, either to give information about it, or to comment on it, or to reflect opposing opinions about it? Is it to create a portrait of a particular personality? Or is it perhaps to be combinations of the two—to present a particular idea as seen through the eyes of a particular person?

Of the three, the last is the simplest and most satisfactory basis for an interview. Given that sufficient programme time is available for expression of the idea, a carefully directed (or edited) discussion should bring it out in a form which is easily assimilated by the listener, and the interviewee will reveal himself a great deal more readily than he would in a scripted talk (which in many cases will reveal only that he has literary aspirations but limited histrionic powers—facts which are rarely relevant to the main issue).

The portrait of a personality is more difficult, and I'd much prefer to turn this into a personality-plus-idea spot before setting out on the interview. I hate "star" interviews when they revolve around such questions as "Tell me about your latest film," "What do you think of England?" "What's it like working with so-and-so?" or "What's it like to be rich and famous?" unless any of these actually produce answers which are not smooth, pat, all-you-nice-people clichés. As a matter of fact these questions can be very relevant, in which case there may be a way of asking them which will produce a real answer. But on the whole there must be something I really want to know about a person's opinion or experience—that isn't already common knowledge—before I decide on the interview. If a person is genuinely interesting (and not just a Public Relations man's promotion) a reason for interviewing him will crop up sooner or later. It may provide the solution in the remaining category of programme, that which is based originally on an idea. Putting together personality and idea, when both had previously been thought of separately, often produces excellent results.

When something starts out as an idea on its own it may be that an interview is not the appropriate way of expressing it in the available time: for example, a brief to comment on the progress of L.C.C. Comprehensive Schools, for an American audience, in three minutes maximum, is unlikely to be filled by an interview. It will take so



long to explain what a comprehensive school is and how it differs from other schools that there will be no time for the interview—a straight report would be better (if the feat must be attempted at all). But if an interview is suitable, the “personality” solution will often be inappropriate. Then, the problem is *who* to interview.

WHO TO INTERVIEW

Here, of course, the professional has all the advantages. There are limits, but these are set high. In practice, I can approach pretty well any private individual with a reasonable hope that he will be prepared to help. But where the subject is concerned with the work of some organisation, the organisation often wishes to decide who shall talk and who not—and since the most effective interviewee is not always the best qualified or most senior it is sometimes a matter of some delicacy getting acceptable results.

My own difficulties in broadcasting to an overseas audience are more than most: a much wider range of voices is unacceptable than with a home audience. For a start, strong regional accents are likely to be unintelligible. For example broad Cornish dialect or the broadest Norfolk are practically impossible to understand by non-residents of those two counties, so abroad they will simply bewilder. The other sort of accent that cannot be used is the affected elocution-gone-wrong mouth-full-of-plums tone that any American or Australian will laugh off the air—and rightly so. Any genuine regional accent, if intelligible, is infinitely preferable. Certain accents which are regarded as middle class also fall into the “unacceptable” category.

Often “difficult” cases include people who cannot talk into a microphone in anything but the most complex technical jargon (some Americans are themselves all too good at this), or people who speak only in clichés—a fault which is often accompanied by extreme deliberation. (Some men carry a service rank into civilian life: while the bearer may turn out to have a perfectly acceptable voice and manner, it is—as the doctors say—a contra-indication.) Another

● A close microphone balance is best when using an omnidirectional microphone—say six inches from the mouth and, if necessary, moving backwards and forwards between question and answer. While nominally omnidirectional, certain microphones (particularly those with large casings) may have polar characteristics which make it necessary to angle individually for each voice in turn. Anything louder than the lightest background should be avoided in an unmonitored recording (party effects, for example, can be recorded separately and mixed in afterwards). Backgrounds are always much heavier than they seem.

(Photo by Rolls Royce: Recording for BBC North American and General Overseas Service programme: “Portrait of Derby.” Interviewer, Colin Wills; producer, Alec Nisbett)

important category of difficult speakers—for me—has been Americans-in-England.

Americans abroad are so polite that they can sing the praises of England for as long as you care to hold a microphone in front of them. And even if the praise is deserved it will mean nothing more to listeners back home than “How do you do?”—which leads me to the odd conclusion that if the idea reflects credit to Britain an interviewee-voice which says so must be British.

A manner of accent which would be unsuitable in the interviewed is even more unacceptable in an interviewer. I know only too well that an interest in tapes and tape recording does not necessarily go with a winning voice at the microphone. No recordist should accept without question the cheerful reassurance of friends and relations that “That sounds fine—good as the radio.” When I do any interviewing myself I find that comparison with the work of experts is both chastening and stimulating.

HOW TO GO ABOUT IT

I start by ringing up my “victim.” This is preferable to writing a polite letter, for several reasons: it gets things moving; it

establishes a pleasant informal relationship from the start and also allows me to “audition” the voice for gross faults and to estimate how much I will want to use in relation to the programme as a whole (though telephone and microphone voices can turn out to be very different). Besides this, I can make the important point that nothing should be prepared—and certainly not a script.

If by any mischance, the interviewee has prepared a script by the time I meet him, I try to persuade him not to use it—though, naturally, I read it through to check against the questions I had been intending to ask. Since I will almost certainly have chosen my interviewee for the answers that he can give *without* looking anything up, a script will only get in the way. Its psychological support should be replaced by the assurance that any slips or loss of the thread can be corrected by editing. The knowledge that he can trust the interviewer in this way, can in any case go a long way towards curing nervousness about questions for which he feels he may not be prepared.

The interviewer must do his “homework,” the more so if the subject is at all technical or unfamiliar: he should be able to ask sensible questions. Scientists, for example, get particularly irritated by being asked questions which are off-beam: it’s difficult enough giving a simple answer without having to start off by reconstructing the question to make it relevant. Even with the homework done, the questions may not be the ones the interviewer would choose if he knew as much about it as the interviewee. Of course, full discussion before the take would ensure that there would be no misunderstandings—but it would also flatten and dull the effect. So it’s better to keep the preliminary chat down to the minimum.

After replaying my own interviews on complex subjects I often find that the answers follow a slightly more relevant line than the questions: so that by editing I can avoid confusing the listener by incorrect signposts. In cutting to shape I may finally reject most of a line I plugged away at, concentrating the listener’s attention instead on an answer or turn of phrase which went by almost unnoticed in the interview, but which carries real weight or suddenly illuminates both the subject and the speaker. Not all the careful scripting in the world can do the work of an unusual and surprising turn of phrase or slightly inappropriate word which can turn up in real conversation. When a pop-singer is telling an archbishop what’s wrong with hymns, and suddenly adds “. . . and the lyrics!” this is something which belongs to the personality of the speaker, and puts across his point more effectively than any scripted alternative would. A good interview is the sum of such moments. And when an interview has to be cut for time these are the seconds which are least dispensable.

Although I do little of my own interviewing, I am, whenever possible, present at the interview, whether this is in a studio or out and about. This procedure allows me the opportunity of studying the interviewee to see how the microphone changes his manner and even his words. I want to get an impression of his personality which even a complete unedited interview of a natural speaker may not give. And then, when I edit, I have something to seek to re-create, and an interest in working towards it.

More Top Stars and Shows on E.M.I. 3 3/4 I.P.S. TWIN TRACK Tape Records



EMI 3 3/4 I.P.S. TWIN TRACK TAPE RECORDS CAN BE PLAYED ON MOST HALF OR QUARTER TRACK TAPE REPRODUCERS! ASK FOR SEPARATE LEAFLET OR WRITE FOR FREE LEAFLET TO ADDRESS BELOW.

ALREADY AVAILABLE:—

MR. ACKER BILK · SHIRLEY BASSEY
 BLACK & WHITE MINSTREL SHOW · JOHNNY BURNETTE
 ADAM FAITH · ELLA FITZGERALD · CONNIE FRANCIS
 THE KING AND I · PEGGY LEE · ORPHEUS IN THE
 UNDERWORLD · CLIFF RICHARD · HELEN SHAPIRO
 JIMMY SHAND · THE TEMPERANCE SEVEN
 BOBBY VEE · GIGI · FRANK SINATRA
 THE SOUND OF MUSIC

EMI RECORDS LTD., E.M.I. HOUSE, 20 MANCHESTER SQUARE, LONDON, W.1

FROM ONLY
35/-
 EACH

*The September releases also include "Instruments of the Orchestra" with spoken commentary by Yehudi Menuhin.



THE GREATEST
 RECORDING ORGANISATION
 IN THE WORLD

TAPE RECORDS REVIEWED

Tape records are being issued in larger numbers than ever before and several firms have plans to increase output further. The fullest, most authoritative reviews of the new issues, as they appear, will be printed here. Edward Greenfield, the recorded music critic of *The Guardian*, is responsible for our coverage of classical music, and Don Wedge, of *New Musical Express*, for the popular music.



DON WEDGE

listens to the new Pops issues

COLLABORATION! The Johnny Dankworth Orchestra and the London Philharmonic Orchestra (conducted by Hugo Rignold). Saga (STE 3056), 7½ ips, stereo 63s.; STG 8059 3½ ips, mono. 32s. 6d.

The attempts at combining classical music and modern big-band jazz made by Johnny Dankworth and the late Matyas Seiber in 1959 were historic. After the few public performances of the Seiber-Dankworth "Improvisations for Jazz Band and Symphony Orchestra" it was put on record.

It was issued at the time by the original Saga company and is now available again through its successor.

The piece is heavy listening, but very rewarding. Most previous tries at welding together the two media produced bad classical music and even worse jazz.

Here the result is very encouraging. The symphonic part is used as a dramatic backcloth for the solos of the Dankworth jazzmen. In these new pastures, they forge a path which critics two decades hence will still applaud.

Included on the record, too, is Stravinsky's *Ebony Concerto* originally written for the Woody Herman band and played by the Dankworth orchestra which also joins the LPO for two more pace-making contributions to the classical-jazz link: *Rendezvous* and *A Rondo for Jazz Soloists and Symphony Orchestra*, the work of arranger Dave Lindup and Leonard Salzedo.

This is a case of the stereo version being well worth the extra expense. The mono captures the performance, of course, but dynamics are an important part of these works and are considerably more truly captured in stereo.

LIVING PERCUSSION. The New York Percussion Trio. Esoteric, STVX 4257401. 3½ ips, stereo (four-track) 19s. 6d.

This is a midget tape—with a lot of sound crammed into a small footage at 3½ ips, four-track. The smallest record I have ever been asked to review, it is an interesting novelty, but no more. By

means of over-dubbing, four American musicians produce a dazzling collection of percussive sounds.

As an example of virtuosity, it would have settled better on my ears if put in a framework of some sort of orchestra rather than being so isolated.

YOU MAKE ME FEEL SO YOUNG. Nancy Wright. Saga (STG 8056), 3½ ips, mono. 32s. 6d.

A collection of very good songs—rather better than the singer. Miss Wright is an experienced American cabaret practitioner and, no doubt, successful, but her voice is not very suited to the numbers she chose to record.

There is a swinging accompaniment, by Cesar Giovannini, which is subdued—I would like to have heard more.

The best track: *I hear Music*, which Miss Wright belts and overcomes most of the vocal shortcomings.

SILK SATIN & STRINGS. The Radiant Velvet Orchestra directed by Cesar Giovannini. Saga (STE 3053), 7½ ips, stereo. 63s.

What I said when previously reviewing this record in mono is amplified many times now there is the added sound of stereo.

Giovannini's sweeping strings gain tremendously in lustre. All the songs are very well known. It includes my personal favourite, *Laura*—and as a collector of "Laura's" this arrangement is among the very best.

There is little deliberate separation, in the gimmick sense, but the overall sound is magnificent.

LET'S SWING. Wendell Tracy and his Orchestra. Saga (STE 3063), 7½ ips, stereo. 63s.

I wrote praisingly about the mono version of this record as recently as July. A dance band usually has less to offer stereo than a string orchestra. But this Tracy band is a swinging outfit and is here heard for most of the time in powerhouse cry.

There is an excellent example of separation during a trumpet solo in

MUSIC on TAPE LIMITED

4TH BIRTHDAY

On our Fourth Anniversary we feel like blowing our own *Tea and Trumpets*—(if you will pardon the pun on one of our own records).

So may we remind you . . .

★ 3³/₄I.P.S. MONO

has been available FROM THE START

★ 3³/₄I.P.S. 4-TRACK STEREO

has been available for over two years—in fact we were the first company to produce 4-track stereo tapes in the U.K.

★ Through our Associates, SOUNDTRACKS Ltd., we developed Dynamic Fidelity, and are continuing to carry out research into the many problems of top-quality tape duplication.

The material we offer covers a wide range and our catalogue gives all the details. Ask your dealer for a copy. If you have difficulty write to:

Tape Recordings London Ltd

188, VAUXHALL BRIDGE ROAD,
LONDON, S.W.1
TATe Gallery 9615

The MULTI-PURPOSE TAPE RECORDER!

Cinecorder



Revolutionary

- The K.G.M. Cinecorder is a high quality 2 track tape recorder, which can be used for all ordinary tape recording purposes as well as for adding sound to slides and cine films.

The Cinecorder is the only comprehensive tape recorder, that has been designed with additional facilities to cover the needs of the cine user. It has many new and unique features that make it so much easier to compile sound tracks for films, and even to record lip-sync. dialogue while shooting.

A few of the features are . . .

- ACCURATE TAPE TIMING indicating in seconds.
- A NEW method of Superimposition, with many advantages.
- TWO-CHANNEL MIXING.
- PUBLIC ADDRESS FACILITIES.
- NEW CONTROL FOR CUEING and Cross Fading.
- POWERFUL ELLIPTICAL HIGH-FLUX LOUDSPEAKER in detachable stand-up lid.

RETAIL PRICE IN THE U.K. £75

For complete details:—

KGM electronics Ltd

BARDOLPH RD., RICHMOND
SURREY RICHmond 7171 (5 lines)

YES!



Demonstration Tape

Ⓢ ⓐ Ⓒ ⓐ Tapes are records too!



Dankworth & The London Philharmonic



The Fantastic Toyshop

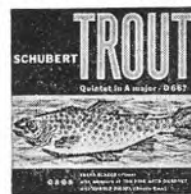

Schubert Trout Quintet



Muskrat Ramble—Doc Evans



Chakaris Sings Gershwin

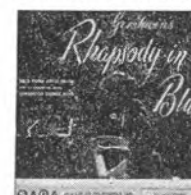

Rhapsody in Blue/
American in Paris—
Joyce Hatto

Q: what is a Gramophone?

A: there are two sorts of Gramophone—those which play discs, those which play tapes.

Q: what is a Gramophone record?

A: a disc or tape.

Yes! your tape-recorder is first and foremost a gramophone too. It is more flexible than a disc-gramophone because it can also record. But its primary purpose is to reproduce *original* sound, and this is more perfectly recorded, more permanently recorded, more precisely recorded on tape-records. This view, increasingly held by music-lovers who value the *original* sound, has caused the fantastic upsurge in the sale of tape-record gramophones. Besides, the stereo of the concert hall and recording studios goes straight to tape and stays on tape *on tape-records*.

SAGA tape-records, both mono and stereo, on 7½" and 3¼", are the Commonwealth's most *accepted* tape-records. SAGA tape-records are on sale at your nearest record-retailer (naturally). Alert record-retailers retail both sorts of records—pure, perfect, and permanent tape-records, as well as other records. SAGA tape-records use *SCOTCH brand* tape exclusively.

Ask your nearest retailer for a free SAGA tape-record catalogue. In case of difficulty write direct to SAGA RECORDS LTD., at 127 Kensal Road, London W.10.

Ask for



by name

SAGA RECORDS LTD., 127 KENSAL RD., LONDON W.10

Gotham Jump but it is as a combination that this band is most successful.

It makes good dance music—for listening, too.

FAVOURITE SHOW TUNES. Sorkin Strings. *Saga* (STE 3057), 7½ ips, stereo. 63s.

A good tune cannot be recorded too many times—that seems to be the opinion of the manufacturers. Almost everything I have listened to this month has been recorded at least a hundred times. *If There is Someone Lovelier than You*, one of the best numbers on this tape, is rare.

The Sorkin Strings rely a great deal on cellos—more than most orchestras. It makes a change, but is not as mellow as it could have been and the overall sound is rather tepid.

NAT "KING" COLE SINGS MORE FAVOURITES. World Record Club. (TT 169), 3½ ips, mono. 29s.

This is a delightful record. A major singing star in a set of songs, all good and several of them among his biggest hits. They were recorded more than a

decade ago, and—unusually for a name artist—these are no longer available on disc, I suspect.

Age does not wither in any way as far as Cole is concerned. Although he celebrated 25 years in show business in August, his voice has not deteriorated (or improved, for that matter) like, say, Frank Sinatra's.

The accompaniment does sound old. Nearly all the backings are by dance bands, whereas today strings and choirs are present on many of his sessions.

An extra bonus is the final track, *Three Little Words* which is a feature for a swinging, effervescent piano from Cole—with no singing. (He began as a pianist, of course, and still plays during a long act). On this, the bass is under-recorded—another sign of age, for today I am sure it would have been heard more prominently.

It is as a vocalist though that Nat Cole has his biggest following. I was grateful to re-discover *I'll Never say Never Again*. You may prefer *Funny*, *Little Boy That Santa Claus Forgot*, *Weaver of Dreams* or *Lush Life*. I like them all.

made by his friend and finest interpreter, Sir Adrian Boult, provides a definitive and most persuasive performance.

The delightful slow coda to the first movement with its violin solo harks back to the early Vaughan Williams of the "Lark Ascending," and then the second movement begins with a typical quirk of the later Vaughan Williams, a strange solo on the flugel-horn, marked to be played without vibrato and with strange oriental-sounding interruptions from the rest of the orchestra.

The recording keeps up World Records' very high standard of mono 3½ ips tapes, but this is not the most brilliant recording from the Everest source. My one complaint about the issue is the absence of programme-note.

PROKOFIEV Symphony No. 5. London Symphony Orchestra conducted by Sir Malcolm Sargent. World Record Club (TCM 29), 3½ ips, mono. 29s.

This is the most Tchaikovskian of Prokofiev's symphonies, with passion, broad expansive melodies and a genuine Russian flavour. Unlike the little Classical Symphony written during Prokofiev's years of exile from Russia, this is not, however, a deliberate imitation of an earlier composer, and the work remains highly typical of Prokofiev in every bar, destined I imagine to become one of the most enduring of twentieth century symphonies.

Sargent's performance, I am afraid, does not bring out the passion, as some disc versions do, and for once the London Symphony Orchestra sounds a little dispirited. But the recording is very good, and some may actually prefer the underplaying.

ELGAR "ENIGMA" VARIATIONS. Introduction and Allegro for Strings. London Philharmonic Orchestra conducted by Sir Adrian Boult. World Record Club (TT 158), 3½ ips, mono. 29s.

It is astonishing that Boult, still unquestionably the greatest interpreter of Elgar, has had to wait till now to replace his ancient recording on 78 rpm discs. His interpretation has changed. As I remember the scratchy old 78s the performance with the old BBC Symphony Orchestra was brisk but grand at the same time.

Whether through the effects of mellowing age or merely a temporary mood at the time of the recording this is a restrained performance. The speeds are very much on the slow side, and even in the two great climaxes of the *Nimrod* Variation—surely one of the most expansively beautiful melodies ever written—and the final variation representing Elgar himself, Boult keeps his forces back a little. This disappointed me at first, but several hearings have convinced me how satisfying this performance is.

The Introduction and Allegro for Strings, another assured masterpiece of Elgar's, is a splendid companion-piece. Apart from overtures and incidental pieces there are few concert works of this length (about 15 minutes) and Elgar's supreme success in moulding a balanced form of his own makes it surprising other composers do not follow his example.

The recording is splendid—like the performance not inflated, but warm and clear at the same time.



EDWARD GREENFIELD

considers new Classical issues

CHORAL CLASSICS. Vaughan Williams "In Windsor Forest"; Stanford *Te Deum* in B flat; Parry "Jerusalem"; Mendelssohn "Hear my Prayer"; Brahms "How lovely is Thy Dwelling-place"; Mozart "Ave Verum Corpus." Elsie Morison, the Bach Choir and Jacques Orchestra conducted by Dr. Reginald Jacques. World Record Club (SIT 53), 7½ ips stereo. Playing time 45 mins. £3.

When Dr. Reginald Jacques retired a couple of years back World Records had the enterprise to record him with the choir and orchestra which he had made famous. The programme chosen for this farewell was ideal—a combination of choral favourites with a delightful and rarely heard cantata by Vaughan Williams, *In Windsor Forest*.

It is in fact a selection of separate items from Vaughan Williams' opera based on Shakespeare's "Merry Wives of Windsor" and called "Sir John in Love."

The Cantata begins with a captivating setting of "Sigh no more, ladies" for women's voices with delightful play on the "hey-nony-nony" ending of each stanza. There follows a rollicking drinking song for the men, a piece called "Falstaff and the Fairies" for soprano solo and chorus, a wedding chorus and an epilogue, with one of those rousing and beautiful melodies that are typical of the composer.

The Stanford *Te Deum* loses a great deal in atmosphere from not having a church setting. This is a little plodding and Parry's *Jerusalem* too does not out-rouse the blood as it should. Elsie Morison sings Mendelssohn's *Hear my Prayer* most beautifully though many will miss having a boy's voice. I per-

sonally prefer the security of a soprano as fine as Elsie Morison. The other two choruses are both devotionally done in the old Jacques manner.

But attractive as the tape is, it would be even more so had the recording been sharper-edged. In the original disc version there were some obvious patches of distortion where the chorus tended to blast. The tape, I think, is rather better, but the improvement seems to have been achieved at least in part by a cutting down of the frequency range. The stereo adds atmosphere, and so many listeners I am sure will be able to put up with a fairly low ceiling: a nice mellow sound without any suspicion of brilliance.

VAUGHAN WILLIAMS Symphony No. 9. London Philharmonic Orchestra conducted by Sir Adrian Boult. World Record Club (T 144), 3½ ips, mono. 29s.

As late as the war, few would have given Vaughan Williams much chance of completing a cycle of nine symphonies, yet after his 75th year he suddenly seemed to take on a lease of creative life, and this, his final symphony was completed at the age of 84, less than a year before he died.

In all honesty it is not Vaughan Williams' greatest symphony. At times, particularly in the first movement, he seems to be striving after a rather grandiose manner without providing a profound enough argument to go with it. I personally much prefer the lighter and less pretentious Eighth Symphony, but if to my mind the overall structure is too loose, there are still many moments, often beautiful, which only Vaughan Williams could have created, and this recording

TAPE RECORDING SIMPLIFIED

At some time or other, the thoughts of the reader who uses his tape recorder as a serious medium for listening to music, will have turned to how and why this phenomenon occurs. He will most likely have dismissed the answers and decided that the whole procedure is to say the least complicated. It is! Let me attempt to clarify these thoughts:—

The whole object when recording sound is to reproduce the original as closely as possible. The frequency range of amplifying equipment should be such, that all the notes reproduced are of the same uniform volume irrespective of frequency, provided the input of all notes to the equipment is of equal volume at all frequencies. This is the basis of normal sound reproduction.

With this as a starting point we will see how these results are obstructed and overcome in a good commercial instrument.

The first thing we shall want to do is record the signal on to the tape.

We will assume all input frequencies are of equal volume.

The main obstruction is the failure to record the high frequency notes and is shown on GRAPH 1—line EF. This failure is due mainly to self-demagnetisation. This in itself is far too complicated to give any semblance of a simple explanation. So we shall leave this point alone. The designer's problem, however is to overcome this high frequency loss. He will more often than not ignore the small losses

The resultant recorded signal should then be as required, line AB.

However, to replay this recorded signal is a little more complicated. The designer is once again faced with heavy losses at high frequencies, complicated losses at low frequencies and a severe brain storm, GRAPH 2, line

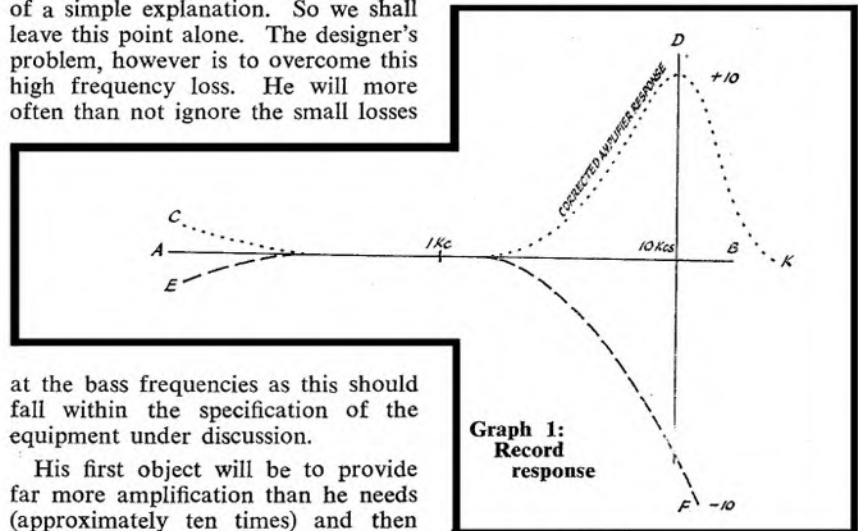

Graph 1: Record response

at the bass frequencies as this should fall within the specification of the equipment under discussion.

His first object will be to provide far more amplification than he needs (approximately ten times) and then reduce all the lower frequencies until the amplifier response is as near line CD as possible, GRAPH 1. One method of achieving this is by circuit G1.

OP. The low frequency loss is due to the voltage output from a torroid (replay) head increasing twice every time the frequency is doubled. This increase would theoretically extend indefinitely in a straight line, but is brought to a stop by the "gap loss" effect, point P (GRAPH 2). This is due to the wavelength of a recorded frequency becoming equal to the width

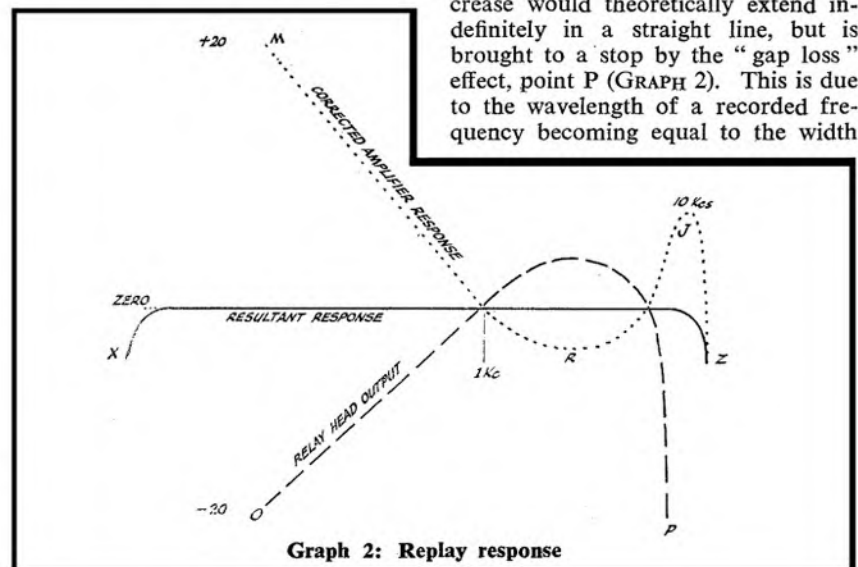

Graph 2: Replay response

How to make both ends meet!
—and stay spliced for life!

SIMPLY USE A BOND MAGNETIC RECORDING TAPE SPLICER

Tape Editing will become a new-found pleasure
Semi-automatic operation
— ONLY —

32/6 complete with 150" x 1/2" jointing tape

CINE ACCESSORIES (BRIGHTON) LTD
15 BOND ST., BRIGHTON Tel. 27674
(Sole U.K. Distributors)

ROBERT HIRST BEGINS THE FIRST OF A NEW SERIES DESIGNED TO ENCOURAGE A GREATER KNOWLEDGE OF THE VARIOUS ASPECTS OF TAPE RECORDING. THIS FIRST ARTICLE DEALS WITH MAGNETIC RECORDING.

of the minute gap in the replay head. At this frequency the output is theoretically zero. This is relative to the speed of the tape, the faster the tape passes the head the higher the frequency of zero output, hence better

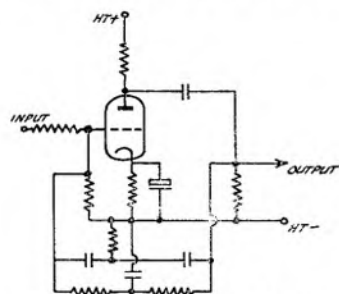

Circuit for Graph 1 record response

high frequency response at higher speeds, or alternatively, the smaller the gap at the same speed, the higher the

frequency of zero output. Zero output is shown by point P, GRAPH 2.

Again, far more amplification than under normal circumstances is required, approximately 20 times. (All losses and gains are referred to level volume at 1 kc.). A rather peculiar dent (point R) is then punched into the amplifier frequency response at the middle frequencies with the hope that line MRJZ, GRAPH 2, will be the result, XZ should then be the resultant replay response.

This once again can be achieved by various arrangements, one of which is shown: Circuit H 1.

As you will see in GRAPH 2, line MRJZ, the replay amplifier is capable of coping with the bass losses, but the treble losses can only be partially overcome, point J, due to the amount of amplification available and the high background noise that would result if

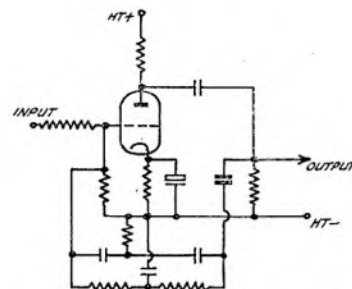

Circuit for Graph 2 replay response

this frequency were boosted further.

These few words should give a surface knowledge of a few of the problems and some of the cures in magnetic recording. Matters do not end here by any stretch of the imagination. And a more basic technical knowledge would be required to make a thorough detailed study of all the intricacies involved.



be an angel

write to us for a free specimen copy of RECORDS AND RECORDING or MUSIC AND MUSICIANS—the illustrated monthly magazines which are *absolutely devoted* to records and music

HANSOM BOOKS LTD. 7 AND 8 HOBART PLACE • LONDON SW1

TAPE RECORDERS

**CERTAINLY NOT THE LARGEST STOCKS
NOR ARE WE THE LEADING SUPPLIERS**

**CERTAINLY NOT THE BIGGEST SHOW-
ROOM OR THE THICKEST CARPET**

**BUT WE CAN SHOW YOU SOME FINE
MACHINES BY TELEFUNKEN, PHILIPS
STELLA, SIMON, BRENELL, VERITONE,
KORTING, TRUVOX, ETC.**

AND WE ARE PREPARED TO GIVE:-

- **PERSONAL ATTENTION**
- **FULL DEMONSTRATIONS**
- **INTEREST FREE TERMS**
- **FULL AFTER SALES SERVICE**

DICKINSONS OF PALL MALL LTD.

11 ROYAL OPERA ARCADE, PALL MALL, S.W.1

TRA 2881

(ARCADE ENTRANCE ADJOINS NEW ZEALAND HOUSE
PALL MALL)

David Allen reviews the

GRUNDIG TK40

AMERICA'S ONLY TAPE RECORDING MAGAZINE

Since 1953, this magazine has totally been devoted to tape recording.

In addition to its timely articles, our columns also feature:

- Tape Reviews
- New Products
- Industry News
- Questions & Answers
- Feedback (letters from readers)
- Crosstalk (an editorial)
- Club News (tape correspondence clubs)
- Tape in Education
- Book Reviews

A one year subscription, including overseas postage, \$4.75

TAPE RECORDING

SEVERNA PARK,
MARYLAND, U.S.A.

Tape-to-Disc Services

RAPID

Recording Service

78's and L.P.'s from your own tapes

Master Discs and Pressings

Recording Studio
equipped with Bechstein Grand

Practising studios
with or without accompanist

Mobile Recording Van
"Off the Air" Service

21 Bishop's Close, Walthamstow, E.17. COP 3889

SOME time ago, I had the pleasure to review a Grundig TK14 recorder and I remember thinking at the time, what an excellent machine it was to handle. I also thought it was a pity that a few extra facilities such as, monitoring through the internal loudspeaker, a second tape speed and an automatic stop, had not been provided. Well, perhaps this was expecting too much from a machine in that price range and it was obviously produced for the less serious minded user.

But now we have the Grundig TK40, and this recorder really has everything! This machine has obviously been designed for the real enthusiast and provides all the features necessary for making first class serious recordings.

Among these features I would list the following as being of particular interest: Three speeds, $7\frac{1}{2}$, $3\frac{1}{2}$ and $1\frac{1}{2}$ ips; four-track operation; internal loudspeaker monitoring, when required; mixing and superimposition facilities. The machine has an excellent signal-to-noise ratio, for a four-track recorder (better than 48 lbs at $7\frac{1}{2}$ ips) and additional multi-disc clutches to remove tape strain. A

pressure sling which is flexible and maintains even pressure over the whole surface of the head; a first class "inching" control; built in tape cleaner etc.; all these and more have been incorporated into a very attractive plastic covered wood case measuring only 16 x 15 x $7\frac{1}{2}$ inches.

The general styling is similar to the smaller TK14 machine which had a white and two tone grey, plastic covered case, with chrome trims.

As one would expect with a recorder with so many facilities, the controls are bound to be numerous; but the manufacturers have obviously given a great deal of thought to the functioning and layout of these. Five clearly identified push buttons provide control of all tape movements and two additional buttons provide switching for the four tracks. The speed change control and mains "on/off" switch is located on the left of the main group of controls and is of the "edge" type with a "neutral" or "off" position between each speed. A slide lever control provides fast forward and fast rewind and this can also be used as an inching control for exact positioning of the tape for editing.

A flexible fabric band takes the place of the normal pressure pads, for holding the tape against the heads. The manufacturers claim that this maintains a more even pressure over the whole surface of the heads and therefore gives

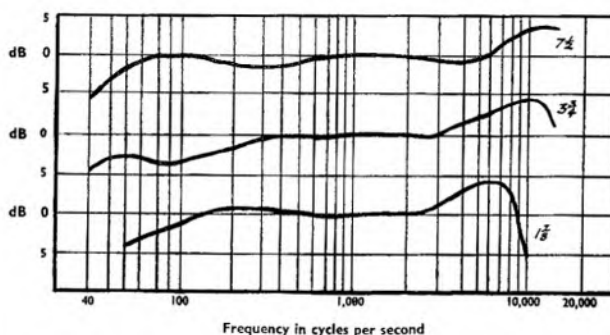

Record/replay
response
curves of the
Grundig TK 40

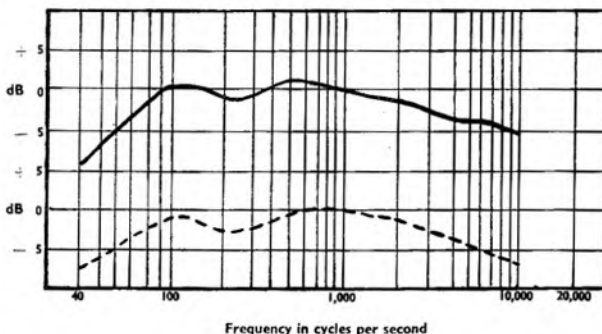

Replay only
response
curves of the
Grundig TK 40,
using standard
CCIR test tape

better high frequency response and minimises "drop-out" effects. The tape position indicator, located above the track selector buttons, is of the three position digital type. A novel feature of this is the provision by press button control for immediate zero reset. A twin button at the other end of the keyboard releases the built in tape cleaning pads.

CONTROLS

Immediately in front of the keyboard, are mounted the two sets of dual controls, with functions as follows; record level control for low impedance inputs. This control also has a push-pull action which is the loudspeaker "on/off" switch. The lower half of this control doubles as a playback tone control or monitor volume. To the right of these, is the second dual control, the top half of which adjusts the record level for microphone recording or volume control for playback. The lower half is a switch for selecting microphone or high-impedance inputs. Finally to the right of these, is the pause control, which is held down for a momentary pause or can be locked in position by sliding it forward. This control halts the passage of the tape past the heads whilst leaving the recorder in the switched "on" position.

The record level indicator is of the popular "twin beam" type and is mounted conveniently in the front of the dress cover. Two sockets are situated on the extreme right of the top panel; one is the microphone input and the other one provides for the connection of a ciné projector. This is a new and very useful feature enabling the enthusiast to record sound for films, or playback a film commentary.

FACILITIES

All the other sockets are mounted on the back of the recorder and apart from the normal high and low impedance input and output connections, provision is made for the connection of accessories such as a remote control unit, monitor amplifier and telephone coupling unit. All these optional accessories are available from the manufacturers.

A recorder of this class, with so many facilities provided, obviously needs a comprehensive and well produced instruction book and this brings me to my first criticism. In my opinion (and also several of my colleagues) the instruction book provided with the recorder is far from adequate. It follows the same pattern as the one provided with the much cheaper TK14 recorder. This consists of a series of photographs of the controls of the recorder with a series of numbers labelling each control. But the numbering sequence was different for each set of instructions so that the same control might have four different numbers depending upon the operation being described.

This method may be ideal for the person buying his first tape recorder, and who might not be so familiar with current terminology as the more experienced enthusiast. The TK40 was obviously designed with the latter in mind, who would I think, prefer the controls to be referred to as they are actually

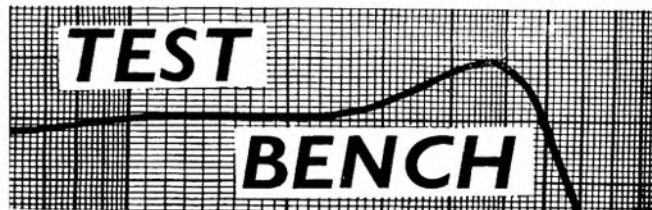
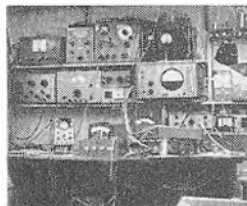

labelled on the recorder. I think also, that the instructions for fitting the spool of tape, the microphone and radio/pick-up connecting lead should be included in the instruction book instead of being printed on three separate pieces of card and packed separately with each accessory. These separate items could quite easily be thrown away with the packing, or subsequently lost.

During the month or so that I had the use of this recorder, I am pleased to say that I could find no faults with the performance or operation of the deck and its mechanism. The motor used is a Papst external rotor type, ensuring exact and constant drive for the three tape speeds. The results obtained from wow and flutter tests proved to be exceptionally good—flutter was practically non-existent and wow was only slightly noticeable at the lowest speed of $1\frac{1}{2}$ ips. Record/replay frequency response checks were made, using the reel of long play tape supplied with the recorder. The results obtained are shown, plotted in the accompanying graph, and were measured from the low impedance output socket with the tone control set for maximum treble.

The replay only response, was checked using a standard test tape recorded to C.C.I.R. standards. The output was measured at the high impedance outlet socket and the response shows that the playback equalisation does not quite follow the C.C.I.R. characteristic. The tone control provided, however, has sufficient range to enable tapes recorded to this standard to be replayed without much loss of musical balance. But if the output is fed via an external amplifier and speaker, a slight amount of bass and treble lift will be required. Hum and noise level measurements were taken at both the high and low impedance output sockets and were found to be better than those claimed.

The microphone supplied with the recorder, is the Grundig GDM18 moving coil microphone. This was found to give excellent results for speech recordings, due to the fact that the microphone has a falling characteristic below about 300 cps and therefore does not suffer from the booming usually associated with moving coil microphones. Additional subjective tests were carried out by making musical recordings via the diode input connection. Replaying these through the internal speaker gave quite good results, within the limitations of the small speaker and cabinet.

Connection of a good quality external speaker did not bring about an expected improvement of reproduction, in fact the results were very disappointing. Reference to the circuit diagram showed that this is probably due to the fact that no negative feedback is provided over the pentode output stages. Of course, if really first class reproduction is required, the output should be fed to an external amplifier system via the high impedance output socket.

To sum up, I give full marks to the Grundig TK40 for provision of so many facilities; its superb tape handling mechanism; ease of operation; general styling and sound mechanical construction. If you are a serious enthusiast and are contemplating buying a recorder in this class, I would thoroughly recommend the Grundig TK40.

The price is £78 15s.

CORRECTION

We apologise for a printer's error in the Test Bench review of the September issue, concerning the price of the Truvox PD86. This unit is in fact retailing at £63, and not as shown. The specification of one of the valves was also incorrect. The valve used in this instrument is an ECC83, not an ECC81 as stated.



In this feature you can check your nearest dealer who is a hi-fi specialist giving expert attention to tape equipment.

LONDON

HI-FI CENTRE

Branch of **KINGS ELECTRONICS**
178, HIGH STREET, E.17

Walthamstow's Leading
Stockist of all makes of

TAPE RECORDERS AMPLIFIERS, TUNERS, etc.

Free Demonstration in the
comfort of your own home
PHONE **AMH 6242 or COP 4488**

Lee Electronics

THE TAPE RECORDER &
HI-FI AUDIO SPECIALISTS
400, EDGWARE ROAD, LONDON, W.2

London's leading Stockists of High-Fidelity and Audio Equipment.
Many Bargains in new and
reconditioned Equipment

SEND FOR FREE LISTS OF RECORDING
TAPES, RECORDERS, AMPLIFIERS, ETC
All Machines demonstrated for performance on
Record and Playback. All leading makes of HI-FI
equipment from stock
PADDINGTON 5521

- ★ TAPE RECORDER HIRE
- ★ TAPE TO DISC 78 & LP
- ★ RECORDING STUDIO
- ★ TAPE RECORDER REPAIRS
- ★ SALES—EXCHANGES

MAGNEGRAPH

1, Hanway Place, London, W.1.
Tel.: LANgham 2156

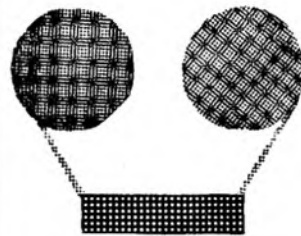

NEW PRODUCTS



A versatile model

LATEST of the models to be announced by Stereosound Productions Ltd. is the Carousel Unit-Tape.

This is basically a twin-track recorder fitted with a B.S.R. Monardeck. Provision is made in the cabinet for the owner to fit optional extras such as a record-player transcription unit, radio tuner or to store tapes or discs.

The tape recorder section provides a single playing speed of 3½ ips, and accommodation for 5¼-inch spools. This allows a playing time of 64 minutes per track using standard play tape (1,200 ft.).

The quoted frequency response is 60-12,000 cps ±3dB, with the signal-to-noise ratio given as better than 40dB, and the wow and flutter figures stated to be better than 0.4 per cent r.m.s.

A 9 x 5-inch loudspeaker provides an output of 2½ watts, and output sockets are provided for a 15-ohm unit. Use of this mutes the internal unit. A high impedance output is provided, plus a crystal microphone impedance input socket. Facilities are provided for monitoring, with independent adjustment of volume when recording.

The cabinet is a polished walnut veneer with brass fittings, lined sycamore and leathercloth, and the dimensions are 14 x 24 x 31 inches high.

For the owner desiring the record-player fitment, the unit also contains an RC2 auto changer consisting of a Garrard auto-slim unit with GC8 head. This is mounted in a timber structure, the sides of which form two record storage spaces inside the cabinet. The mains supply and pick-up output are plugged into the amplifier (without any soldering) and the unit is fitted to the cabinet by the insertion of two bolts provided. An AM4 Tuner Unit is fitted on the right of the tape deck, using ready-fitted plugs.

The price of the Unit-Tape is



Carousel Radiotape

42 guineas, plus the cost of the individual extra units which are as follows:—RC2 changer, 10½ guineas, AM4 tuner, 8½ guineas, and FM3 tuner 18½ guineas. Other prices are available from the manufacturers.

Stereosound Productions Limited, Capital Works, L2-14, Wakefield Road, Brigg, Yorkshire.

MIDLANDS

SOUND BUSINESS

Specialists in
Sound Reproducing Equipment
Stockists of Butoba, Grundig,
Sony, Tandberg, Vortexion, etc.

Backed by a
First-Class Service Department

TYSONIC

W. M. Tyson M.Brit.I.R.E.
41 Russell St. Leamington Spa
phone 24935

Leonard G. Francis presents— SHEEN TAPE RECORDER CENTRE LTD.

Specialists in Tape Recorders
and Accessories etc.

—THE CENTRE FOR—

FRIENDLY HELP — SALES — SERVICE
HOME DEMONSTRATIONS ANYTIME
— MODELS FROM 19 GNS.—
PRE-RECORDED TAPE: LANGUAGES
DANCE — CLASSICS — JAZZ

CALL—WRITE—PHONE

8 Station Parade, Sheen Lane, Sheen,
London S.W.14 (next to Mortlake Station, S.R.)
Showrooms: PROSPECT 0985 10 a.m.—7 p.m.

A NEW TANDBERG

ELSTONE Electronics Ltd., announce an addition to their range of Tandberg tape recorders. The new model made in Norway, is to be designated the Series 7 stereo recorder.

It is available in two versions, Model 72, two-track, and Model 74, four-track. Three speeds are provided, $7\frac{1}{2}$, $3\frac{3}{4}$, $1\frac{7}{8}$ ips, and it will accommodate seven-inch reels. Playing time available is therefore 64 minutes per track using standard-play tape (1,200 ft.). Fast wind is achieved within two minutes for this length.

Quoted frequency response is 30-20,000 cps (40-16,000 cps ± 2 dB) at $7\frac{1}{2}$ ips; 30-14,000 cps (40-10,000 cps ± 2 dB) at $3\frac{3}{4}$ ips; and 50-7,000 cps (50-5,000 cps ± 2 dB) at $1\frac{7}{8}$ ips. Wow and flutter figures (r.m.s.) are given as within .15 per cent at $7\frac{1}{2}$ ips, .2 per cent at $3\frac{3}{4}$ ips, and .3 per cent at $1\frac{7}{8}$ ips. Signal-to-noise ratio below maximum recording level (five per cent distortion) is quoted as 55 dB for the four-track model, and 58 dB for the Model 72. Cross-talk rejection is stated to be better than 60 dB and better than 70 dB for the Model 74 and Model 72 respectively.

In all other respects the models are identical. They incorporate a number of facilities, including ability to change tape speeds whilst running, recording level indicators, facilities for monitoring, playback on one track whilst recording on another, auto stop operated by tape running out, digital rev. counter, pause control, and a bass boost switch (12 dB at 70 cps).

Inputs are provided for two microphones (1.5 mV r.m.s. 3.3 M ohms; and

two line inputs—adjustable external presets 7 mV to 7 volts r.m.s. Outputs include phono sockets supplying external speakers or hi-fi amplifiers.

A speaker switch selects three positions for (a) internal, two Goodman's 7 x 4 inch ellipticals, (b) internal plus external, and (c) external units only. Two three watts output stages are incorporated.

A combined record/playback head and ferrite core type erase head (minimum erasure 70 dB) are incorporated. The bias and erase frequency is 85,500 cps, distortion five per cent.

Power requirements are 110, 125, 145, 200, 220, and 245 volts, 50 cycles, 85 watts

Motor pulley for 60 cycles at 24s. 0d. extra). The valve line-up includes one ECC82, two ECC83, two ECL 86, two EAM86, two Philips AC107 transistors, and a selenium rectifier 124 mA 250v.

Dual volume controls are fitted. During recording, the upper control knob adjusts the recording level for channel one and the lower control knob operates channel two. These same controls are also used during playback or when switched to straight-through amplification.

Both models are housed in a teak cabinet measuring $15\frac{3}{8}$ x $11\frac{7}{8}$ x $6\frac{3}{4}$ inches. The instrument alone weighs $27\frac{1}{2}$ lb., and with a luggage-type carrying case, $32\frac{1}{2}$ lb.

Both are available at 93 guineas, with the luggage case an optional extra at £7 1s. 8d.

Elstone Electronics Limited, Edward Street, Templar Street, Leeds, 2.

A tape timer unit

SYMPHONY AMPLIFIERS LTD. announce a Tape Timer Unit suitable for use with all existing tape recorders, designed from their experiences with the unit incorporated in their Symphony Automatic recorder.

The new unit will be available in two versions. Model B has both the clock/time switch and process timer, and Model A is without a process timer. They both possess all the normal facilities of

switching on and off at pre-set times any household appliances up to a current load of 13 or 15 amps. Operation is for 200-240 volts, 50 cycles, AC.

Model A contains an electric time unit with a 12-hour dial and two control knobs. These can be selected for setting "on" and "off" times, and the other for selecting automatic "on" and "off"; automatic "off" only, or "manual operation," i.e., automatic switching cut-out. In addition there is a neon indicator and a 13- or 15-amp socket for mains output. Model B is similar but in place of the neon indicator there is a special Process Timer with readings in one minute divisions up to 25 minutes.

Model A can be used with any mains operated recorder, but Model B is suitable for use with recorders such as the new Revox stereo machine, the Telefunken 75, 76, 77, and 85 series, and also by the Stuzzi Tricorder. Both models will take heavy current appliances as well as the tape item.

The various prices of the Symphony Tape Timer units are as follows:—Model A, complete, 10 guineas; Model B, complete, 15 guineas; time switch (round or rectangular), 6 guineas; process timer (0-30 minutes), £6 10s.; and the mounting plate, bare metal, is 10s.

Symphony Amplifiers Limited, 16, King's College Road, London, N.W.3.



In this feature you can check your nearest dealer who is a hi-fi specialist giving expert attention to tape equipment.

THE SOUTH

PORTSMOUTH and SOUTHAMPTON

Tape Recorder Specialists

APPROVED AGENTS FOR:—
PHILIPS GRUNDIG - FERROGRAPH
VORTEXION, ETC.

- ALL MAKES OF TAPE RECORDERS SUPPLIED
- ACCESSORIES AND HI-FI EQUIPMENT
- PART EXCHANGES AND SECOND-HAND MACHINES
- PROMPT AND SKILLED SERVICING

RECORDING MACHINES LTD.

299 Commercial Road, Portsmouth
Telephone: 23097
4 New Road, Southampton
Telephone: 27092

For all your Tape Recorder and Cine requirements

UNIVERSITY CAMERAS

of

SOUTHAMPTON
12 BARGATE STREET

Telephone : 28547

SCOTLAND

GLASGOW

Tape Recorder Specialists

APPROVED AGENTS FOR:—
PHILIPS - GRUNDIG - FERROGRAPH
VORTEXION, ETC.

- ALL MAKES OF TAPE RECORDERS SUPPLIED
- ACCESSORIES AND HI-FI EQUIPMENT
- PART EXCHANGES AND SECOND-HAND MACHINES
- PROMPT AND SKILLED SERVICING

RECORDING MACHINES LTD.

60 ST. VINCENT STREET, GLASGOW, C.2
Telephone: City 3847/8

TAPE RECORDERS
(Bournemouth) LTD (Exeter)

Southern England's Biggest Centres for
PHILIPS · FERROGRAPH
GRUNDIG · TELEFUNKEN
BRENELL · AND ALL LEADING MAKES

Accessories by return Call, write or phone

THE TAPE RECORDER PEOPLE

874 Christchurch Rd., BOURNEMOUTH Tel. 45096
3 Seamoor Road, WESTBOURNE Tel. 64292
1 Sidwell Street, EXETER Tel. 75779

SOUTH LONDON TAPE RECORDER and HI-FI CENTRE

The Largest Selection of Highest Quality Recording and
Reproducing Equipment on Show. 200 Machines Displayed.

FERROGRAPH 4AN	...	81 gns.
FERROGRAPH Stereo 422U	...	110 gns.
BRENELL Mk. V "M"	...	88 gns.
PHILIPS Stereo	...	92 gns.
REFLECTOGRAPH Type 'A'	...	105 gns.
REPS. R.10. 4 Track	...	69 gns.
SIMON S.P.5	...	93 gns.
TANDBERG Stereo 6	...	110 gns.
TRUVOX Twin Track	...	82 gns.
VORTEXION WVA	...	£93.13.0
SONY Stereo 521	...	124 gns.
AMPEX 971 Stereo	...	225 gns.

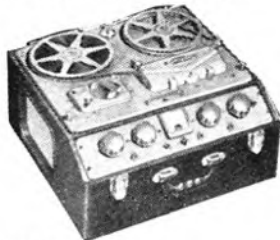

AMPLIFIERS BY

LEAK ROGERS QUAD
ARMSTRONG DULCI JASON

TUNERS

DULCI LEAK QUAD FM and AM
ARMSTRONG ROGERS

MICROPHONES

GRAMPIAN DP4 RESLO
FILM INDUSTRIES CADENZA

SPEAKERS

LEAK SANDWICH QUAD ELECTRO-
STATIC LOWTHER GOODMANS
WHARFEDAILE

Large stock of shop-soiled and used Tape Recorders at bargain prices.

THE LEADING TAPE-RECORDER AND HI-FI MAIL SPECIALISTS

- No interest terms on tape recorders over 12 months (18-24 months available).
- Generous allowance on your Tape-recorder, Hi-Fi equipment.
- Immediate delivery (normally waiting time on above machines is 12-16 weeks).
- Tape recorders for hire from 45/- weekly.

CALL IN PERSON OR WRITE TO OUR MAIL ORDER DEPT. FOR IMMEDIATE ATTENTION

REW EARLSFIELD LTD. TELEPHONE:
BALHAM 7710

266, UPPER TOOTING ROAD, LONDON, S.W.17

EDUCATIONAL RECORDINGS LTD.

Pioneers of Personalised Psycho-Tapes and Discs, also supply pre-recorded tapes and discs on many vital and interesting subjects including:—

POSITIVE PERSONALITY :: HYPNOTISM
MIND MANAGEMENT :: AUTO-SUGGESTION
PUBLIC SPEAKING, ETC.

Latest release:—

TECHNIQUE OF SLEEP-LEARNING

Free Brochure describing our full range of recordings gladly sent under plain cover on receipt of a post card. Write to:

EDUCATIONAL RECORDINGS LTD.

(Dept. 10,) 21, Bishops Close, Church Lane, London, E.17

THE WAL D-MAG, head demagnetiser, long nylon covered probes £2 10s. 0d.
WAL GAIN transistorised pre-amplifiers, Mono £5 10s., Stereo £7 10s. and Hi-Gain (latter CCIR equalised)-£7 16s.
THE WAL BULK Eraser - £7 18s. 6.
Available from all leading dealers.
(Wholesale include T. D. & B. London, and A. C. Farnell, Leeds).

WELLINGTON ACOUSTIC

LABORATORIES LTD., Farnham, Surrey (Fnhm 6461)



TAPE RECORDING AND HI-FI

By the Editor of TAPE Recording Magazine

The best available introductory guide

160 pages, 40 illustrations. 13s. 3d. (including postage)
from Tape, 7, Tudor Street, London, E.C.4

H. D. KIRK

Stereolectrics

LIMITED

Have the facilities for you to hear the
finest in High Fidelity Sound Equipment

Tape

Disc

Radio

with a varied selection of furniture
to house your choice

Specialists in High Fidelity

Phone: 23093

150 HIGHER BRIDGE STREET

BOLTON

The Berean Forward Movement

(NON-SECTARIAN
NON-DENOMINATIONAL)

600 reliable expositions of
the Bible available on tape
(3½ ips) at very low loan
charges (free to the blind and
infirm).

Invaluable to all Christians,
from teachers to tyros; for
Bible Study groups or private
meditation. Supporting
literature also available.

Send for free, complete list to
B.F.M. "Eastgrove,"
Marsham Way,
Gerrards Cross,
Bucks.

BINDERS

The ideal way of preserving
your copies of

TAPE RECORDING MAGAZINE

No more torn covers and dog-eared edges ★ No more
hunting for those mislaid copies ★ Each copy is inserted
as received to form a completely bound volume for permanent
reference ★ All pages open flat and effect secure binding
with steel bars from first to last copy ★ Strong board
binders covered with rexine with the title printed in gold
on spine.



PRICE 14s. 6d.

(post free)

From: TAPE Recording Magazine, 7 Tudor Street, London, E.C.4

READERS WITH PROBLEMS

AS a newcomer to tape recording I wish to use my machine, among other purposes, for dictation.

I am surprised, however, to find that there appear to be no accessories on the market by which one might adapt an ordinary tape recorder to this end.

I would need (a) a switch that could be operated by one hand whilst holding the microphone in the other, and (b) a foot switch for operation by a typist; or, better still, a foot switch that would serve both purposes.

Even as a complete novice, however, I realise it is not simply a matter of incorporating such switches into the mains lead coming from the machine since it would not then be sufficiently warmed-up either to record or play-back immediately.

I should be pleased, therefore, to learn if other readers have solved this problem and if so, how?

E. CRAVEN.

Flixton, near Manchester.



I WONDER if your readers can help me with a small problem which I have had for some time.

I recorded the Service of the Consecration of Coventry Cathedral; however, the direct recording lead was not screened properly and this produced a whistle on the recording.

If any one who has a recording of this is willing to make it available to me for dubbing, please notify me. I am willing to pay the cost of postage both ways.

I would also like to take this opportunity of saying how much I enjoy reading your magazine and I congratulate you on producing a first-class paper.

PAUL L. NEWMAN.

Aylesbury, Buckinghamshire.



I HAVE an old Scophony Baird Mk. II tape recorder in use in addition to my Vortexion. I wish to keep the older recorder, purchased in 1953, working in order to transfer some of my ancient recordings.

My difficulty is replacing the spring belt which is operated from the pinch wheel to the take-up spool. The Baird Company has had many changes, and it is not possible to get these items direct. Do any of your readers know where such a belt could be obtained?

T. BROWNER.

1, Montpelier Terrace, Blackrock, Dublin, Eire.

Letters to the Editor

A CLUB THAT DIED

HOW correct your correspondent J. Williams is, in your September edition, I used to be the treasurer of the Wakefield club, which was dissolved in January of this year. This club was among the first few dozen in the country to start and was, although I say it myself, very active. It held in its existence an annual audio fair and was never short of activities at its meetings.

In the few months towards the end of its life, not enough members turned up at meetings to make any activity really worthwhile, and one can hardly invite speakers to come, when you know full well that there will only be a small audience. There were always plenty of other things to do, but members were either not interested or if they were, so few people turned up, that the programme planned for the meeting fell flat.

Three members of the club, all on the committee—including myself—decided we had had enough. The three of us put it to an extraordinary general meeting, that the club be disbanded and an informal group formed which could meet in one another's homes. In this way, there would not be the overhead expenses of a meeting place, nor would it be necessary to have a subscription—and thus no one could say he could not afford to join the club, though on the other hand as we intended to amuse ourselves rather than sit back and watch demonstrations, only the really active would take part.

The club was in fact disbanded and many members said they would come along to the meetings of the newly formed group. Not one of them came. The three of us who thought of the idea remain—Peter Wainright, Stephen Gaunt and myself. But we are not short of ideas. We enjoy ourselves far much more now, providing our own activities than when we were on the committee of the club trying to please everyone else, and failing to do so.

We meet at least twice a week. We have built our own studio and equipped it. We record programmes for four old-

folks homes, and are shortly starting on recording programmes for the local broadcasts to hospitals service. We go out with a portable recorder from time to time, and occasionally visit other clubs.

Mr. J. Williams asks "Are tape clubs with committees and regular meetings really necessary?" I say they are not. If members are co-operative and fully active then a club is an ideal meeting place. If not, then it is far more interesting and satisfying for a group of similarly interested enthusiasts to meet informally in their own homes, or a mutual meeting place and get on with whatever activity they choose.

If a new club were to re-form in Wakefield I would not join it. I get far more satisfaction now from our present activities. I use a recorder six nights out of seven, and have had one for five years—and I'm not bored yet!

Incidentally, keep up the good work, your magazine is excellent. I've been a reader since the first volume.

MIKE STOREY.

Wakefield, Yorkshire.

TAPE RECORDING CROSSWORD

Solution to last month's puzzle

R	U	N	N	I	N	G	S	S	F
E	I	D	R	E	P	E	A	L	
C	A	N	T	O	A	O	A		
O	E	L	M	O	O	T			
R	E	P	A	I	R	S	L	A	I
D	I	S	C	M	E				
N	N	E	O	B	S				
U	S	R	C	A	N	T	R	I	P
M	A	D	O	S	O				
B	D	C	O	R	S	O	N		
E	L	P	I	C	O	L	I	S	
R	O	A	C	E	T	A	T	E	

FOR BEST RESULTS USE **ferrania** MAGNETIC RECORDING TAPE



News from the Clubs

BIRKENHEAD

G. Prandle of 74, Salacre Lane, Woodchurch Estate, Birkenhead, Cheshire is keen to hear from tape enthusiasts who are interested in the formation of a tape club. He mentions the Merseyside area, and details the districts of Heswall, Creasby, Wallasey or Hoylake as a probable location.

Interested persons should contact him direct.

BOSTON

Boston Soundhunters had their first regular fortnightly meetings at Pilgrim College on June 12 and 26. Membership had shown an increase since their inaugural meeting held in May, and the members also welcomed along their first lady member.

The earlier meeting was devoted to basic principles of tape recording, the speaker being the club's leader, Philip Towell. He illustrated his talk with recordings, demonstrating the versatility of his machine with tapes of a child's first words, an interview with a Fair showman, a jazz group session, and sounds from Amsterdam's streets.

Types of microphones and tapes were briefly discussed, and advice on editing and maintenance was given.

At the later meeting members took along their own recorders for a head cleaning and de-fluxing session. A remarkable absence of oxide deposit was noted, even though one machine came complete with cobweb and two spiders! A specially prepared test tape was played at various speeds, and one of the new E.M.I. Tape Records was demonstrated.

The group has been accepted into membership of the Federation of British Tape Recording Clubs. Mr. Towell, recently won third prize in the World Tape Pals (UK Section) competition for a ten-minute tape on the subject *Our Town*.

CAMBRIDGE

Recent meetings of the Cambridge Society have included an "at home" when they invited members of the Northampton Tape and Cine Society along. The hosts took charge of the first half of the evening, and Richard Hillman gave a talk on *Portable recorders—at work and play*. This was followed by *Town and Gown*, with Len Brown talking about the different gowns used in the colleges in their town compared with other universities. Among the examples shown was one gown (worth over six Ferrographs, I understand) made for the Lady Chancellor of Vancouver University.

During the second half of the evening the guests showed a tape/slide show plus an amusing production entitled *All in a day's work*.

Members made another special visit to Dunstable to record a Hammond Organ in the "Green Man."

The society has stepped up its social services under the direction of Richard Hillman, and the members would be pleased to hear from other clubs with material suitable for such cases. The first issue of the club's bi-monthly magazine was published on June 1.

A special turn-out of recording enthusiasts is expected in the town for October 17, 18, and 19, when the society will present the Cambridge 1962 Audio Exhibition.

Ten well-known manufacturers in the tape field have promised to support the exhibition by taking stand space for static and demonstration displays, in addition to advertising space in the Exhibition Catalogue.

The club's own exhibit will include a stand with membership details and general information, a home-built equipment display stand, and a recording and closed circuit television studio. Programmes will be relayed from the Studio throughout the three days of the show, and a competition, to find the voice of Cambridge, will be staged with valuable prizes.

ELTHAM

The formation of a tape and cine club covering the areas of Eltham and Well Hall in South-East London is proposed. Mr. M. McCoy, of the Royal Herbert Hospital, Woolwich, London, S.E.18, is the instigator, and he would like to hear from interested persons so that an initial meeting can be held.

He states he owns two tape recorders, has several more at his disposal, and also owns an 8mm cine camera.

GOSPORT

A tape club has been formed in Gosport, Hampshire, bearing the title of the Solent Tape and Audio club. Meetings are held on the second and fourth Thursdays of each month at the Gosport Community Association, Bury House, Bury Road. Tape exchanges with other tape clubs are welcomed.

Secretary: R. V. W. Temlett, 30, Blake Court, South Street, Gosport, Hampshire.

HELSEBY

Another new club recently formed is that in Helsby. Further information regarding meeting dates and venue can be obtained from the secretary, Mr. M. Sutton, 5, Sandringham Avenue, Helsby, Warrington, Lancashire.

INTERNATIONAL VOICES OF YOUTH

Founded and operated by the "leaders of tomorrow" as a non-profit, non-political, non-sectarian organisation striving for world peace through tape exchanges is the description afforded the International Voices of Youth in a handbill recently addressed to this office.

Information of this new tape club is available from Post Office Box 3041-C, San Mateo, California, USA.

MIDDLETON

One of the most recent meetings of the Middleton club saw the presence of a local rock'n'roll group. Trouble with a mixer unit created a little set-back initially, but they managed to cope using only a single microphone. The results, they note, were a little disappointing, and arrangements are being made to have another crack at it in the not too distant future.

Monthly competitions have been organised and subjects are being set for short feature tapes. The idea is to gather together material for a future entry in the British Amateur Tape Recording Contest, and a stipulation is being made barring the use of copyright material.

Winner of the first contest was Tom Ingham who produced a tape describing his recent visit to the Channel Island of Jersey. The judge was George Wells, one of the London members.

The following competition, result not yet announced, was to be judged by the members of the West Herts club. The subject was "My tape recorder."

The club is keen to establish contact with other clubs, particularly those in the near vicinity, with a view to inter-club visits. Apart from the West Herts members, they are already in contact with the Jersey society.

A club magazine is to be produced. This is to include a series of articles by Joe McCormack, who is to back up his theoretical features with practical demonstrations during meeting nights.

Six Philips battery portables are now owned by members, and they recently had the opportunity of comparing these with their first demonstration of the Grundig TK1. Various points were found in favour of either machine, the Grundig proving popular because of its 3 1/2 ips speed and its pause control, and the Philips scoring high marks by virtue of its reproduction through its own speaker, and the ideal threading facilities.

Since these machines were introduced to the club they have "had to have lectures on interviewing." This chore was left in the very capable hands of Jim Carmel who "seems to be able to turn a hand to most things."

NORTHAMPTON

A change in their meeting place was recently made by the members of the Northampton club. Completion of a rebuilding programme of the former venue led to an increased hire charge so the members moved to the Cross Keys Hotel in Sheep Street.

During the past months their activities have included recording several concerts given to the blind, and a recording session with a local ladies' choir. They have also persevered with the club film *Friday the Thirteenth*. Filmed in the local market square this film is a comedy bank robbery, on 8mm cine with taped sound.

On June 21 the members played a triple role in the local Carnival in aid of various welfare societies in the town. The club entered a float entitled *Cafe de Paris* which was a mobile filming and recording unit. Two recording parties were at various points along the route to record the events, and the cine members operated their cameras. The results were to be made available to Homes for the Aged, and for children. The sound commentary will also be used as part of the programme for their service for the blind.

TAPE CRUSADERS FELLOWSHIP

The latest issue of the magazine on tape produced by the Tape Crusaders Fellowship is now available. Included in this sixth edition are a variety of topics related to their policy of encouraging tape recording in Christian service. An item about the use of audio/visual aids includes a brief survey by the Rev. Sinclair Walker, of Wallasey, and Mr. Joseph Ross, of Aberdeen, talks about the use of foreign postage stamps in the teaching of scripture.

Another discussion concerns itself with paperback books, and titles of Christian interest in particular. Also included is a lively five-minute talk from the Rev. John Bramley on *Christians and Cosmetics*, and Irvine Swift, musical teacher of the Henshaws School for the Blind, Manchester, provides the music throughout.

Copies of the tape are available either by sending a spool of tape (600 ft.) for a dubbing at 3 1/2 ips (or the equivalent length if a 7 1/2 ips copy is required) to Francis Newing, "Kingswood," Park Road, Bracknell, Berkshire. There is a nominal fee of a 1s. for expenses, and return postage is requested. New copies may also be obtained, price 19s. from David Lazell, 25, Wheatland Drive, Leicester Road, Loughborough, Leicestershire.

YORK (1)

Plans are being laid for a special "York Tape Week" to celebrate the third anniversary of the formation of the York tape club. Among proposed features are to be a dinner and dance, tape demonstrations, a variety show, tape night, an audio exhibition.

The week will also be designed to coincide with a special recruiting drive. The club aims to raise its membership, and has set its sights for 100 fully paid-up members.

At present members have a wide and varied programme of activities, including regular tape contacts with the clubs in Bournemouth, Bristol, Hove, Keighley, Northampton, Rugby, and the R.A.F. Tape Society. They are currently designing a display to be included in the exhibition being organised by the Northampton club members.

A re-shuffle of committee members recently occurred. Apart from the chairman and secretary, who retain their posts, the newly elected officials are Peter Lambert, vice-chairman; John Derry, publicity officer; and Brian Lambert, tape secretary.

A plan to increase their funds to enable the club to buy its own equipment, is to include the organisation of a tape party. Members and visitors will be invited to bring a tape recorder or pay 2s. 6d., and a celebrity will be asked to open the proceedings.

Secretary: G. Machen, 17, Melbourne Street, Fishergate, York.

YORK (2)

A second tape club has been formed in York. The new group has been formed by the Acomb Community Association, and meetings are held every Thursday evening at the Association's premises in Front Street, Acomb.

Secretary: B. Snowden, 51, St. Paul's Terrace, Holgate Road, York, Yorkshire.

THE BEST OF BOTH WORLDS

That is what you can expect when you buy a Brenell tape recorder—top quality, high performance and versatility at a reasonable price. The Mark 5 deck at 28 gns., the Mark 5 recorder at 64 gns. or the Mark 5 Type M at 88 gns. are all unbeatable in their class.

Mere illustrations can only show the functional appearance of these machines but a practical demonstration will reveal the realism and beauty of recorded sound obtainable from a Brenell. Ask your specialist dealer for a demonstration and you will hear what we mean.

All Brenell tape decks are fitted with an hysteresis synchronous capstan motor with an outer rotor and a large statically and dynamically balanced flywheel. This drive system is widely regarded as the most efficient for use in tape recorders. "Wow and Flutter" are reduced to below 0.1% at 7½ ips.

A NEW DEVELOPMENT FROM BRENELL

THE MK 510 DECK

This new introduction is basically the same deck as the Mark 5 but modified to take 10½" N.A.B. as well as standard spools. All other features remain as before. It is available in hammered gold or hammered grey finish and is supplied for use on 200/250V 50 c/s mains only. The additional cost is 7 gns.



MARK 5
DECK: 28 GNS



MARK 5: 64 GNS



MARK 5
TYPE M:
88 GNS

Brief Specification—Mk 5 Deck

Four recording speeds 1½, 3¾, 7½ and 15 i.p.s. • 3 independent motors
• Interlocked controls • Pause control • Digital rev. counter
• Fast rewind (1,200ft. in either direction in 45 secs.) • Provision for additional heads • 8¼in. reels accommodated.

Other recorders in the range:—

3 Star 58 gns.
3 Star stereo 89 gns.
Mark 5 stereo £99 12s.

Brenell

BRENELL ENGINEERING COMPANY LIMITED

1a DOUGHTY STREET, LONDON, W.C.1, Tel: HOLborn 7356 (3 lines)

ORDER TO NEWSAGENT

FOR

"TAPE RECORDING MAGAZINE"

Published on the third Wednesday in every month. Price 1s. 6d.

To
(Newsagent's name and address)

Please deliver me one copy of "TAPE Recording Magazine" each month until further notice.

(Signed)

Address

TAPE Recording Magazine is published by Print & Press Services Ltd., 7, Tudor Street, London, E.C.4, and distributed by Trans-World Circulation Co., Park Royal Road, N.W.10.

ORDER FOR ANNUAL SUBSCRIPTION TO "TAPE RECORDING MAGAZINE"

Please post me one copy of "TAPE Recording Magazine" monthly for one year. I enclose £1 in payment to commence Issue.

(Signed)

(Address)

Classified advertisements

Rate—Sixpence per word (minimum 5s.); Trade, ninepence per word (minimum 10s.); box numbers, one shilling extra. Payment with copy. Copy should be sent to Advertising Department, "Tape Recording Magazine," 7, Tudor Street, London, E.C.4.

TAPE RECORDS

FOREIGN LANGUAGES ON TAPE from 38s. 6d. French, Italian, Spanish, German, Russian. Full money-back guarantee. Details from BBS Ltd. (Dept. TRM), 10, Bayley Street, London, W.C.1.

LEARN WHILE ASLEEP. Hypnotize with your recorder. Fascinating, educational. Astonishing details FREE! Write: Sleep-Learning Research Association, Box 24-TE, Olympia, Washington, U.S.A.

PRE-RECORDED TAPES. Unique complete catalogue listing all makes, Mono, Stereo, 7 $\frac{1}{2}$ and 3 $\frac{1}{2}$ ips, including World Record Club tapes. Call for FREE copy or send 1s. mailing fee. Dept. T.R.I., Teletape Ltd., 33, Edgware Road, W.2. PAD 1942.

Christian Tapes suitable for Hospitals, Blind and Shut-ins. S.A.E. D. O. French, 136, Tollington Park, London, N.4.

All American Pre-Recorded Stereophonic Tapes Supplied. Send 4s. 6d. for complete catalogue, all makes. Imported Records, 42 Broadway, London, S.W.1.

NEW EQUIPMENT

TAPE RECORDERS. SAVE FROM 30 per cent to 60 per cent on the original price. Large stock of second hand, new, shop soiled machines. All guaranteed. Obtainable on our NO INTEREST TERMS. Best part exchange allowances on your existing equipment. CALL, WRITE, PHONE today for free list. Quotation and details. Our Mail Order covers the whole Country. R. E. W. Earlsfield Ltd., 266, Upper Tooting Road, London, S.W.17. Balham 7710.

FERROGRAPH 422 and 4A/N always in stock ready for immediate delivery and demonstration: City and Essex Tape Recorder Centres, see page 3.

TAPE SPLICING, EASY, ACCURATE, with EASYSPLICE tape splicer. 5s. 9d. Easysplice, 30 Lawrence Road, Ealing, W.5.

New Patented Magnetic Tape Threader, fits all circular and diamond slotted reels. Attaches to tape with its own tongue. Holds loaded reel from spilling. Sold throughout U.S.A. and Canada. Manufacturers: Tunetime Recording Enterprises, Box 652, Adelaide Street, P.O., Toronto, Canada. Send 5s. for 6 Threaders to U.K. Distributors, B. Tindell, 33, West Mall, Clifton, Bristol, 8.

FOR SALE

EXCEPTIONAL PURCHASE of ex-Government Ferrograph Recorders. Models R1444, G200, YD, £35 each; 2AN metal cased £49 each; One only YDC £50. Teleonic Ltd., 92, Tottenham Court Road, London, W.1. LAN. 1381.

GRUNDIG MA1 Transistor Tape Pre-Amplifiers suitable for use as microphone transformer, pick-up and tape head booster. Listed at 4 $\frac{1}{2}$ gns. offered at £2 17s. 6d. Send for full details and free lists. Lee Electronics, 400 Edgware Road, W.2. Paddington 5521.

CLARION PORTABLE RECORDER perfect condition. List price 25 gns. Accept 12 gns. Goode, 86, Barcombe Avenue, Streatham, S.W.2.

MAGNETIC TAPE

TAPE BARGAINS IN ALL SIZES. Example: Top Brand 5 $\frac{1}{2}$ in., 1,200 ft., 19s. 6d.; P. & P., 1s. 3d. S.A.E. for list. Large choice of new and used recorders, E. C. Kingsley & Co., 132, Tottenham Court Road, London, W.1. EUS' 6500.

ASK YOUR DEALER for American Ferro-dynamics "Brand Five" recording tapes—the best tape value!

All types stereo and mono American tapes. Catalogues from Charles, 480, Muswell Hill Broadway, N.10.

"BRAND FIVE" American Tape, long play 5 in. (900 ft.) 18s. 6d.; 5 $\frac{1}{2}$ in. (1,200 ft.) 23s. 6d.; 7 in. (1,800 ft.) 35s. Sent by return, post free. Watts Radio, 54, Church Street, Weybridge, Surrey.

TAPE TO DISC

J. & B. RECORDINGS—"The Wedding Specialists." Tape to Disc, 60-minute LPs—unbeatable prices.—14, Willows Avenue, Morden, Surrey. Mitcham 9952.

JOHN HASSELL RECORDINGS. Tape to Disc, 50-minute LPs—lowest prices. Studio and mobile services.—21, Nassau Road, London, S.W.13. Riverside 7150.

TAPE-TO-DISC RECORDING SERVICE. All speeds. 50 minute LP's. Photographic sleeves with all recordings.—E.R.S., 162, Shirland Road, London, W.9.

TAPE TO DISC RECORDING. Reduced prices. Finest professional quality, 10-inch LP—35s. (32 mins.), 12-inch LP—40s. (45 mins.). 7-inch EP 17s. 6d.

48-HOUR POSTAL SERVICE. S.a.e for leaflet to Deroy Sound Service, 52, Hest Bank Lane, Hest Bank, Lancaster. Tel.: H.B. 2444.

Your private tape recordings transferred to finest quality unbreakable discs. Prices from 12s. 6d. to 37s. 6d. Satisfaction guaranteed—prompt service. S.A.E. for leaflet on request. S.S.S., 28, Viewforth Terrace, Sunderland. 57032.

TAPE EXCHANGES

FRIENDLY FOLK ASSOCIATION, Torquay (Est. 1943). Social introductions, Pen-friends, Book-lovers, Stamps, Photography, Tapesponding. Members 100 Countries.

Join BRITAIN'S BIGGEST, Friendliest, Tape Exchange—"WORLDWIDE TAPETALK." 35, The Gardens, Harrow, S.A.E. for particulars.

MISCELLANEOUS

REPRESENTATIVES REQUIRED to obtain tape recordings for our Tape Division. Should you have talent for recording and material available, please contact Capital Entertainments, P.O. Box 340, Port Elizabeth, South Africa.

TAPE PROTECTORS—top quality shaped polythene bags with generous closure—protect your tapes from the damp and atmospheric change and prevent 'sticking'. Per dozen, 3 in.—1s. 6d.; 4 in.—1s. 8d.; 5 in.—1s. 9d.; 5 $\frac{1}{2}$ in.—2s.; 7 in.—2s. 4d.; 8 $\frac{1}{2}$ in.—2s. 8d. From your Dealer, or from SWAINS Papercraft Ltd., Dept. 6, Buckhurst Hill, Essex.

Part-time employment available, all areas, for owners of tape recorders. Mainly evening work, no expenses, guaranteed monthly payment. Write Bishop, Natproban Chambers, South Street, Worthing, Sussex.

Index to Advertisers

	Page
A. Brown & Sons Ltd.	43
Agfa Ltd.	5
Akai Trading Co. Ltd.	41
Armstrong Radio & TV Co. Ltd.	42
BASF Chemicals Ltd.	44
Berean Forward Movement	34
Brenell Engineering Co. Ltd.	37
Cine Accessories (Brighton) Ltd.	28
City & Essex Tape Recorder Centre	3
Dickinsons of Pall Mall Ltd.	29
Educational Recordings Ltd.	34
Elstone Electronics Ltd.	43
E.M.I. Records Ltd.	24
E.M.I. Tape Ltd.	12
Francis of Streatham	39
Garrard Engineering & Manufacturing Co. Ltd.	6
Gevaert Ltd.	21
Gramplan Reproducers Ltd.	39
Hansom Books Ltd.	39
Hi-Fi Centre	32

	Page
Howard Tape Recorders	18
K.G.M. Electronics Ltd.	26
Lee Electronics	32
Magnegraph	32
Neville Brown & Co. Ltd.	35
Northgate (Cameras) Ltd.	2
Politechna (London) Ltd.	13
Rapid Recording Services	30
Recording Machines Ltd.	33
Reslosound Ltd.	43
R.E.W. Earlsfield Ltd.	34
Saga Records Ltd.	26
Sheen Tape Recorder Centre Ltd.	32
Simon Equipment Ltd.	4
Stereolectrics Ltd.	34
Tape Recorders (Bournemouth) Ltd.	33
Tape Recordings London Ltd.	27
Tellus Ltd.	7
The Ferrograph Co. Ltd.	16
The Recorder Company Ltd.	42
Truvox Ltd.	9
Tysonic	32
University Cameras	33
Wellington Acoustic Laboratories Ltd.	34
World Record Club	10 and 11

Alive to every sound

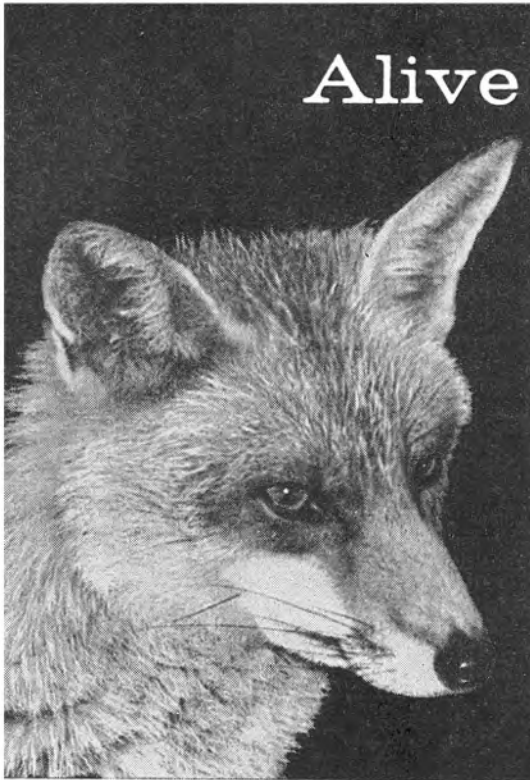

Like the ears of this wary fox, the Grampian DP4 microphone is sensitive to an extremely wide range of sounds. With its uniform frequency response from 50 to 15,000 c/s, the reliable, medium-priced DP4 will greatly improve the standard of your recordings.

Grampian DP4

—also for broadcasting, public address and call systems.

Low impedance microphone, complete with connector and 18 ft. screened lead **£8. 0. 0.**
Medium and high impedance models . . . **£9. 0. 0.**

A complete range of stands, swivel holders, reflectors and other accessories is available.

GRAMPIAN—sounds like the real thing!

Write or phone for illustrated leaflets:

GRAMPIAN REPRODUCERS LTD
Hanworth Trading Estate, Feltham, Middlesex. Feltham 2657



FRANCIS OF STREATHAM

● THE BEST OF THE AUDIO FAIR TAPE RECORDERS ARE AT 169/171

Brenell Mk. V. Model M	88 gns.	*Tandberg Series VI	110 gns.
*Brenell Mk. V	64 gns.	Stereo 1/2 or 1/4 Tr.	76 gns.
Brenell 3 Star	58 gns.	*Tandberg Mono, 3B	79 gns.
Brenell 3 Star Stereo	89 gns.	*Telefunken 85KL	59 gns.
Cossor 4 Tr. 1602	37 gns.	*Telefunken 95	69 gns.
Cossor 4 Tr. 1601	59 gns.	*Telefunken 96 4 Tr.	95 gns.
Cossor 4 Tr. 1603	28 gns.	*Telefunken 97 Stereo	55 gns.
Elizabethan Popular	24 gns.	Truvox Series 80/2 Tr.	59 gns.
*Ferrograph 422 or 424	110 gns.	Truvox Series 80/4 Tr.	82 gns.
*Ferrograph 4AN	81 gns.	Truvox R7	79 gns.
*Ferrograph 4AN/S	88 gns.	Uher Universal	91 gns.
Fidelity Argyll Major	28 gns.	*Vortexion WVA	£93.13.0
Fidelity Minor	22 gns.	*Vortexion WVB	£110.3.0
Grundig TK14	35 gns.	*Vortexion C Stereo	£148.10.0
Grundig TK24	55 gns.	Wyndors Heron	25 gns.
*Grundig TK60 Stereo	128 gns.	Wyndors Victor	45 gns.
Philips 4 Tr. 3514	27 gns.	Latest 4-track Models by Philips,	
Philips 4 Tr. 3541	34 gns.	Cossor and Stella	
Philips 4 Tr. 3542	59 gns.		
Philips 4 Tr. Stereo 3536	92 gns.		
*Reflectograph 'A' 1/2 Tr.	105 gns.	BATTERY PORTABLES	
*Reflectograph 'B' 1/2 Tr.	115 gns.	Philips Portable	24 gns.
*Reflectograph 'D' Deck	75 gns.	Butoba	69 gns.
Robuk	36 gns.	Grundig TKI	29 gns.
*Simon SP5	93 gns.	Clarion	19 gns.
Sony Stereo	75 gns.	Clarion Twin Set	8 gns.
Sony 1/2 and 1/4 Track	124 gns.	Clarion Phonotrix	39 gns.
Stellaphon 4 Tr. 456	28 gns.	Minivox C	23 gns.
Stellaphon 4 Tr. 454	37 gns.	Fi-Cord	59 gns.
Stellaphon 4 Tr. 455	59 gns.	Stella	25 gns.
Stuzzi 4 Tr. Junior	26 gns.	Stuzzi Memo-Cord	25 gns.
Stuzzi Tri-Corder	63 gns.		

*Microphone extra

FACTORY FRESH BATTERIES ALWAYS IN STOCK

● Tape to disc service ● Tape copy service ● RECORDER HIRE SERVICE

LEADING STOCKISTS OF EQUIPMENT FOR TAPE and HI-FI

. . . and NO EXTRA FOR CREDIT TERMS

- ★ Minimum Deposit
- ★ No Interest or Service Charges on H.P. up to 18 months
- ★ Free Service during Guarantee Period

Prices subject to alteration as announced by manufacturers

● MICROPHONES AND MIXERS

Grampian DP/4 Dynamic	£8.0.0
Lustraphone LD/66	£4.2.6
Lustraphone VR/64	
Ribbon	£7.17.6
Lustraphone LFFV/59	
Dynamic	£8.18.6
Simon 'Cadenza' Ribbon	£10.10.0
Reslo Ribbon or Dynamic	£9.12.6
Reslo Cardioid	£10.12.6
AKG Stereo Dynamic	
D.88	£19.19.0
Grundig Mixer	£16.16.0

Also in stock: Microphones by ACOS, FILM INDUSTRIES, TELEFUNKEN. All Walgain Products.

● TAPES AND ACCESSORIES

Standard, Double Play and Long Play in all sizes by all leading makers.

- Pre-recorded Tapes by Columbia, H.M.V., Saga, Music on Tape, etc.
- Bib, Bond and Romagna splicers.
- Matching transformers Plugs, sockets, etc.

HI-FI DEPT.

WITH THE BEST OF THE AUDIO FAIR 181 Streatham High Road

- STEREO AND MONO AMPLIFIERS by

Quad	EMI	Walgain
Leak	Rogers	Dulci
Armstrong		
- TUNERS by

Quad	Rogers	Chapman
Leak	Dulci	Armstrong
- LOUDSPEAKERS by

Quad	Philips
W.B.	Wharfedale
Goodmans	Tannoy
Audistatic	Mordaunt
Leak	Kef
- MOTORS, PICKUPS, by

Garrard	Tannoy
Goldring-Lenco	Connoisseur
Shure	Decca
Stereo	Ronette
Philips	All-Balance
B & O	SME
Ortofon	

All types of Diamond and Sapphire styli, stereo and mono. Microlifts, Garrard SPG3, Acos Dust Bug.

- CABINETS Record Housing Leak 'Southdown'

Please note our only addresses as below

169-171 STREATHAM HIGH ROAD, LONDON, S.W.16

Between St. Leonard's Church and Streatham Station

STReatham 0466/0192

Hi-Fi Dept. 181 STREATHAM HIGH ROAD. S.W.16

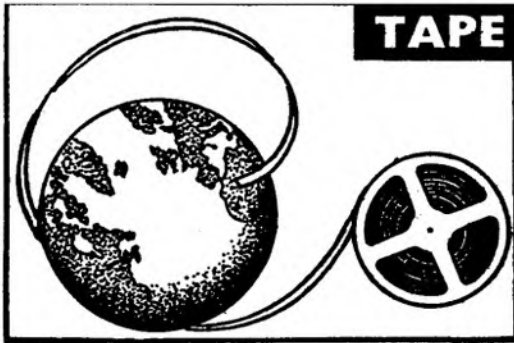

TAPE EXCHANGES

Tape goes round the world! There is no comparable means—except costly travel—to form friendships with men and women in other countries and continents. Every month, in this feature, we list enthusiasts who are seeking tape contacts.

Atkins, Ron (40). 16, Highfield, Meriden, near Coventry, Warwickshire. Stereo colour photography, motoring, music. 15, 7½, 3½, 1½ ips. 7-inch spools. Brenell, Countess, Stella recorders. U.K. female contacts required.

Austin, Bunny (44). 12, Cornwall House, Durham Hill, Dover, Kent. Photography, motoring, musical instruments. 7½, 3½, 1½ ips. 7-inch spools. Robuk RK3. U.K., U.S.A. and Europe.

Beale, Lt.-Cdr. John W. (42). Command and Staff Course, Naval War College, Newport, Rhode Island, U.S.A. English folk music. 7½, 3½ ips. 7-inch spools. Philips 400 (EL3536), stereo, four-track. U.K., U.S.A., British Colonies.

Beswick, Dave (31). 63, Ashton Road, Luton, Bedfordshire. Astronomy, philately, classical music. 7½, 3½, 1½ ips. 7-inch spools. Regentone recorder. Kenya, India, Australia and Canada.

Billings, J. (22). 33, Ruskin Walk, Herne Hill, London, S.E.24. Philately, and travel. 7½, 3½, 1½ ips. Robuk RK3.

Black, Morag. 173, Tuke's Avenue, Bridge-mary, Gosport, Hampshire. Art and jazz. 3½ ips. 5½-inch spools. Sound Riviera. Canada and U.S.A.

Blakeley, A.F. (34). 15, King's Avenue, Boston, Lincolnshire. Sound effects, 8mm cine, drama (stage management), 7½, 3½ ips. 5½-inch spools. Uher 195.

Bond, L. (36). 12, North Close, South Nor-manton, Derbyshire. 8mm cine and still photo-graphy, political science, history, classical music. 3½ ips. 5½-inch spools. Regentone RK20. U.K. and Europe.

Booth, K. F. (32). 12, Lincoln Road, Maiden-head, Berkshire. Photography. 7½, 3½ ips. 7-inch spools. Telefunken 95. U.S.A., Canada, England.

Bridge, Brian (21). 4, Selby Road, Hollins, Middleton, Manchester, Lancashire. Records, people, corresponding. 3½ ips. 5½-inch spools. Grundig TK14.

Carew, David J. (22). 8, Church Street, Malden, Essex. 3½ ips. 7-inch spools. Cossor CR1602, four-track. Overseas.

Casson, David (20). 15, Cameron Drive, Northampton, Northamptonshire. 8mm cine, cinema, all music. 3½, 1½ ips. 5½-inch spools. Grundig TK20, Majestic, Philips EL3585. Female contacts preferred.

Cresdee, Douglas Brian (20). 65, Gregson Avenue, Bridgemarky, Gosport, Hampshire. Motor racing, medicine, people. 7½, 3½, 1½ ips. 7-inch spools. Robuk RK3. German, U.S.A., Canada.

Cross, Michael (25). 3, Coniston Close, Barne-hurst, Kent. 35mm photography, travel, fishing, people. 3½ ips. 5½-inch spools. Grundig TK20, Cossor CR1601, four-track.

England, John R. (29). 12, Dongale Road, Bristol 7. Photography, church work. 7½, 3½, 1½ ips. 7-inch spools. Civic recorder. Overseas, especially Africa.

Fraser, Charles D. (40). 20, Belmont Street, Glasgow W., Scotland. Travel, technical books, dancing. 3½ ips. 5-inch spools. Philips AG8109. Europe and South America.

Goldup, D. (31). 5, Hillside, Southwick, Sussex. "Pop" to classical music, angling, astronomy. 3½ ips. 5½-inch spools. Philips EL3541.

Haijemaalje, Herman J. F. (46). P.O. Box 157, Rotterdam, Holland. 8mm cine, slides, dramatics, music. 7½, 3½ ips. 7-inch spools. Philips EL3541, four-track.

Haliburton, Godfrey (39). 642, Alderson Avenue, New Westminster, British Columbia, Canada. Sound effects, music, general. 7½, 3½, 1½ ips. 7-inch spools. Two Webcoors, Clarion battery portable. All Commonwealth countries. Will send all tapes airmail.

Hardman, John (65). 28, Clyde Road, West Didsbury, Manchester 20, Lancashire. Education, writing, travel, and all music (except jazz). 7½, 3½, 1½ ips. 3-inch spools. Grundig TK830, TK5, TK24, TK40. Overseas only.

Hastings, Leslie R. (38). Council Depot, Digby Street, Bethnal Green, London, E.2. Stereo,

photography, motoring, music. 7½, 3½ ips. 8½-inch spools. Ferrograph 4A/N and 422 (stereo and mono).

Ingham, Thomas (56). 108, Oldham Road, Fallsworth, Manchester. Wide variety of inter-ests. 15, 7½, 3½, 1½ ips. 8½-inch spools. Brenell MK 5, Stelaphone Portable.

Jansen, Gerrard (25). Odstsinge 125, Delfet-Holland. 8mm cine. Photography, music, travel. 3½ ips. 7-inch spools. "Aristona," Stella. English female required.

Johnson, Dennis (46). Peak Hill, London, S.E.26. Photography, light music, improving German speech. 7½, 3½, 1½ ips. 7-inch spools. Repts R10, 4-track. German male or female.

Johnson, Michael (26). 33, Prince of Wales Avenue, Regents Park, Southampton. Classical music, church (L.D.S.). 7½, 3½, 1½ ips. 7-inch spools. Philips 4-track. USA, North England.

Kinham, Walter H. C. (38). 26, Church Road, Tottenham, London, N.17. Photography, people and places, and many others. 7½, 3½, 1½ ips. 7-inch spools. Sound Slimline, and Clarion. Letters not needed.

Lee, Ken (23). Limber Cottage, Front Street, Dundton, Lincs. Christian fellowship tapes, evangelical, etc. 3½ ips. 5½-inch spools. Grundig TK14.

Lockie, Miss Fiona (29). 4, Maryfield Place, Midlothian, Scotland. Reading, swimming, music, geology, travel. 3½ ips. 3-inch spools. Philips recorder. Norway and Holland.

Lund, David (22). Hamden Club, Polygon Road, London, N.W.1. Hi-Fi, electronics, body building. 7½ and 3½ ips. 7-inch spools. Truvox R82.

Maitland, C. (20). 67, Gresham Road, Brixton, London, S.W.9. Theatre, gen. drama, folk music. 7½, 3½ ips. 7-inch spools. Sound (Studio Deck). USA and Canada.

McCoy, Bill (27). 3, Maida Street, Leichhardt, Sydney, Australia. Music, humour, reading. 7½, 3½, 1½ ips. 7-inch spools. Telefunken and Mag-netaphon 96. Japan, Germany, and USA.

Metcalfe, Allan (31). 54, Morely Street, Roch-dale, Lancs. Photography, music and travel. 3½ ips. 7-inch spools. Fidelity Argyl, 2-track. France, and Spain. Male contacts only.

Millar, Charles (35). 43, New Road, Bannock-burn, Scotland. 8mm cine, 35mm B & W. Slides, climbing, classical music. 7½, 3½, 1½ ips. 7-inch spools. Philips 2-track and 4-track. Out-side British Isles. Letters not required. Tapes answered in 48 hours.

Munkittrick, Alex (45). 24, Kenton Road, Earley, Reading, Berks. French language, travel, cycling. 3½ ips. 5-inch spools. Philips EL3541 and 3527. France, USA, UK.

Newman, Leslie (21). 192, The Mall, Harrow, Middlesex. 35mm photography, athletics. 7½, 3½, 1½ ips. 7-inch spools. New Zealand, Australia and Britain.

Pavlicsek, John H. (26). 519, Mackinac Avenue, South Milwaukee, Wis., USA. Cinema, international "pop," jazz and instrumental music. 7½, 3½ ips. 7-inch spools. Roberts 191 (Arkaï),

full-track recorder, and Tanberg 65, 4-track. Europe English/German speaking. Male and female.

Robson, Robert J. (32). "Rosemont," 20, Ewhurst Avenue, Sanderstead, Surrey. Films, music, travel, general interest. 3½ ips. 7-inch spools. Chelsea, 2-track. Male contacts preferred.

Smith, Keith (25). 117, Wykin Road, Hinckley, Leics. Editing and trick recording, Hi-Fi. All speeds, all sizes. Brenell Mk 5, Leavers-Rich. USSR, Germany and Holland.

Tansley, Ron (23). 1, Hodgkinson Street, Netherfield, Nottingham, Nottinghamshire. 35mm colour and b/w photography, films, reading, most popular music. 7½, 3½, 1½ ips. 7-inch spools. Norfield recorder.

Thomas, Louis (35). Basrah Elec. & Water Supply, Basrah, Iraq. Photography (violinist), violin concert and classical music. 7½, 3½, ips. 8½-inch spools. Ferrograph 4s with stereo add unit. English and Arabic.

FAMILY EXCHANGES

Jasper, Mr. & Mrs. D. (25). 17, Tasker Terrace, Rainhill, Liverpool. Photography, music (not "pop"), languages. 7½, 3½, 1½ ips. 7-inch spools. Philips EL3542, 4-track. Spain, South America.

Milner, Mr. & Mrs. J. W. (53). 34, Red Lane, Kenilworth, Warwick. Music (not "pop"), religion, Philos-esperanto. 7½, 3½ ips. 7-inch spools. Sony Stereorecorder, 4-track. Any race, creed or colour. English and Esperanto.

TEENAGE EXCHANGES

Boyce, Terence (17½). 114, Hillcrest Road, Hornchurch, Essex. Films, "pop" music, some modern jazz, general interest. 7½, 3½ ips. 7-inch spools. Truvox R84, 4-track. Female contacts, same age preferred.

Cadier, S.A.C., A. R. J. (18). C/o Officers' Mess, R.A.F., Stanbridge, Leighton Buzzard, Beds. Cycling, camping, "pop" records. 7½, 3½, 1½ ips. 7-inch spools. Robuk RK3.

Hawkins, Ray (17½). 20, Lyndhurst Drive, Hornchurch, Essex. Films, TV, "pop" music, some modern jazz, general interest. 15, 7½, 3½ ips. 7-inch spools. Sceptone 161, 2-track. Letters not required. Anyone same age, female contacts preferred.

Mackenzie, William Fraser (16). 81, Gilmore Place, Edinburgh, Scotland. "Pop" music, angling, general interest. 3½ ips. 5½-inch spools. Grundig TK20.

Sweetman, Peter (16½). 21, The Byeways, Surbiton, Surrey. Jazz, economics, and general interests. 3½ ips. 5½-inch spools. Grundig TK20. Canada, UK, Australia, and Common-wealth.

Taylor, Allan (18). 19, Southfields Avenue, Oadby, Leicester. Electronics, swimming, "pop" records. 3½ ips. 5½-inch. Sobell Festival. USA, Britain.

Walker, Keith F. (16). 26, Bradley Avenue, Houghton-Le-Spring, Co. Durham. Model making, "pop" music, science fiction, general interest. 7½, 3½, 1½ ips. 7-inch spools. Robuk RK3. London, USA, Australia.

Tape recorder owners wishing to make contact with others of similar interests are invited to complete and return this form.

Name Age

Address

(BLOCK LETTERS PLEASE)

Special interests

Speeds to be used Max. spool size to be used

Recorder(s) owned

Special areas to be contacted

(Unless otherwise stated, I am prepared to accept tapes from any part of the world)

Finest Newcomer!

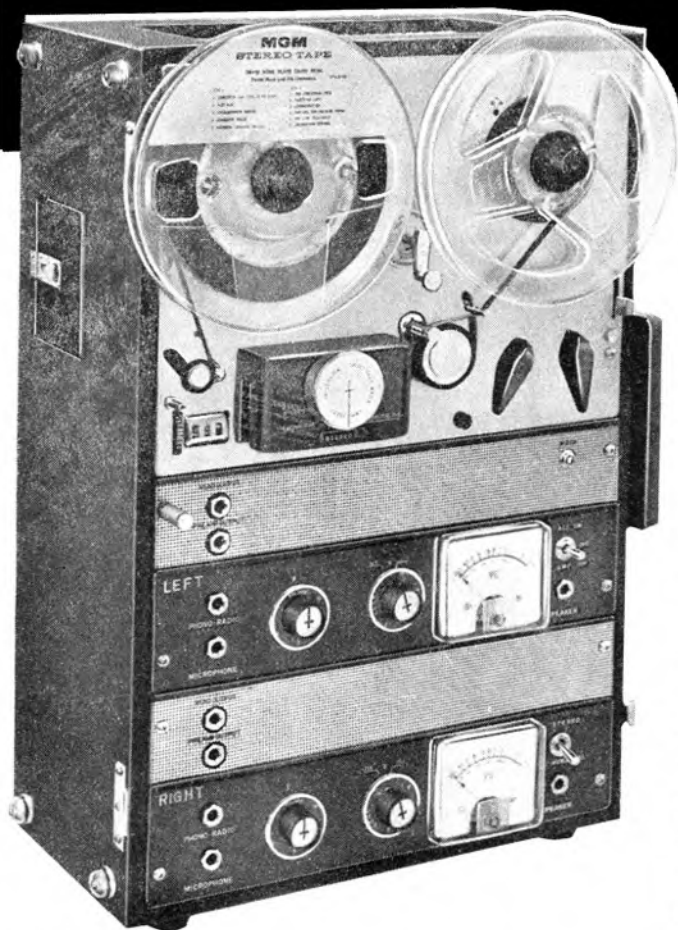

EVERY PERFORMANCE
YOU'VE WANTED

TEST AKAI'S M-6

ACE OF ALL EXISTING 4-TRACK STEREO TAPE RECORDERS, IS NOW RELEASED BY THE WORLD FAMOUS JAPANESE MANUFACTURER, THE AKAI ELECTRIC CO., LTD.

FEATURES:

- 1) Records and plays back either 4-track stereophonic or monophonic and also plays back 2-track prerecorded stereo tapes.
- 2) Single internal speaker can be used for monophonic reproduction with matched stereo speaker system.
- 3) Dual Head and Preamp Outlets are provided for direct connection any other pre-amplifier or stereophonic amplifier.
- 4) Other outstanding features are powerful hysteresis synchronous motor, index counter, interlocked operating controls and automatic stop device.

SPECIFICATIONS:

POWER SOURCE:	AC 100 and 117 volts. 50-60 cps. 220 volt upon request.
TAPE SPEED:	$3\frac{3}{4}$, $7\frac{1}{2}$ and 15 ips.
FREQUENCY RESPONSE:	30-20,000 cps. at $7\frac{1}{2}$ ips. 40-14,000 cps. at $3\frac{3}{4}$ ips.
OUTPUT POWER:	6 W x 2
TUBES USED:	6267 (EF-86) x 2, 12AD7 x 2, 6AR5 x 1, and 6 x 4 x 2.
WEIGHT:	46 $\frac{1}{2}$ lbs. (net in carton)
DIMENSIONS:	14" x 20 $\frac{1}{2}$ " x 8 $\frac{1}{4}$ ".

Call Our Representative :

NORTHGATE (CAMERAS) LTD.

119-125 Wardour Street London W. 1



AKAI TRADING CO., LTD.

883, 3-chome, Kojiya-cho, Ohta-ku, Tokyo

Armstrong Quality Tuners

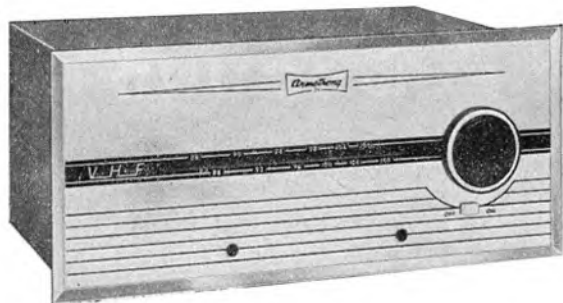

Designed to match any amplifier or tape recorder

T4B FM TUNER (illustrated)	£21 18.0.
T4C FM TUNER (without case)	£19 19.0.
ST3 Mk. 2 AM/FM TUNER	£27 16.0.

We also make a wide range of high fidelity amplifiers and tuner-amplifiers, both mono and stereo, all of which offer top quality performance at reasonable prices.

The T4B model (and uncased version—T4C) is a self-powered high fidelity FM Tuner. Automatic frequency control ensures complete stability and the cathode follower stage, together with the variable output control, enables it to be used with any amplifier or tape recorder. All these features are to be found also in the ST3 Mk. 2 AM/FM Tuner together with coverage of the medium and long wavebands. The AM section includes a ferrite aerial and two IF stages, ensuring good Continental reception, and there is a miniature bright-line indicator for easy tuning.

For first-class recordings from radio, there is nothing better than an Armstrong tuner and we confidently assert that there is no better value on the market.

AVAILABLE FROM LEADING HIGH FIDELITY AND TAPE RECORDER DEALERS THROUGHOUT THE COUNTRY

Write for free descriptive literature to:

ARMSTRONG (DEPT TST) WALTERS ROAD, HOLLOWAY, LONDON, N.7

NORTH 3213

18 Months to Pay

	Deposit	18 Monthly	Cash	
	£ s. d.	Payments	£ s. d.	Gns.
MAINS 2-TRACK				
Truvox R82 ...	5 15 6	2 17 9	55	
Brenell 3 Star ...	6 2 0	3 0 11	58	
Reps. R.10 ...	6 4 0	3 2 0	59	
Brenell Mk. 5 ...	7 2 0	3 6 10	64	
Telefunken 85KL ...	8 6 0	4 3 0	79	
Ferrograph 4A/N ...	9 0 0	4 4 6	81	
Brenell 5 Type "M" ...	9 5 0	4 12 5	88	
Veritone 16 ...	9 13 0	4 15 6	91	
Simon SP/5 ...	9 16 0	4 17 8	93	
Reflectograph "A" ...	11 5 0	5 10 0	105	

4-TRACK MONAURAL

Grundig TK23 ...	4 15 0	2 7 3	45
Brenell 3 Star ...	6 2 0	3 0 11	58
Philips EL3542 ...	6 4 0	3 2 0	59
Cosson CR.1601 ...	6 4 0	3 2 0	59
Truvox R.84 ...	6 4 0	3 2 0	59
Elizabethan Major ...	7 3 0	3 7 11	65
Reps. R.10 ...	7 5 0	3 12 6	69
Grundig TK40 ...	8 0 0	3 18 8	75

4-TRACK STEREO/MONAURAL

Philips EL3536 ...	9 16 0	4 16 6	92
Telefunken 97 ...	10 0 0	4 19 9	95
Akai M.6 ...	13 13 0	6 16 6	130

THE RECORDER CO. presents the superb FERROGRAPH 420

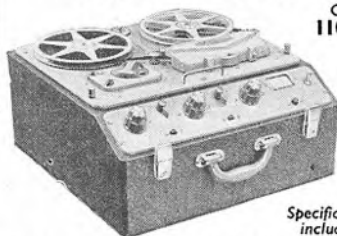

CASH
110 gns.

OR
£20
DEPOSIT
12 monthly
payments of
£7 19 2

Specification
includes:

1. Monaural Record & Playback with continuous monitoring on either channel.
2. Stereo Record & Playback with continuous monitoring on both channels.
3. Facility for echo effects.
4. Simultaneous Record and Playback.
5. Superimposition whilst re-recording.
6. 2 or 4-track models available.

We will be pleased to demonstrate this remarkable model, send for full details

- ★ INTEREST FREE terms
- ★ FREE INSURANCE COVERING YOUR PAYMENTS
- ★ IN THE EVENT OF SICKNESS OR UNEMPLOYMENT
- ★ FREE DELIVERY
- ★ PART EXCHANGES

12 months to Pay

	Deposit	12 Monthly	Cash	
	£ s. d.	Payments	£ s. d.	Gns.
MAINS TWIN-TRACK				
Grundig TK14 ...	3 13 6	2 15 2	35	
Reps. R.10 ...	6 3 11	4 13 0	59	
Telefunken 95 ...	6 3 11	4 13 0	59	

4-TRACK

Philips "Star Maker" ...	2 16 9	2 2 7	27
Elizabethan FT1 ...	3 11 5	2 13 7	34
Philips EL3541 ...	3 15 8	2 16 9	36
Elizabethan LZ29 ...	3 15 8	2 16 9	36
Stella ST454... ...	3 17 9	2 18 4	37
Grundig TK23 ...	4 15 0	3 10 10	45

BATTERY

Grundig TK1 ...	2 13 0	1 15 0	23
Philips EL3585 ...	2 10 5	1 17 10	24
Stella ST470... ...	2 15 0	1 19 2	25
Optacord 420 Battery/ Mains	4 15 0	3 10 10	45
Stuzzi Magnette ...	6 4 0	4 12 11	59
Butoba MT5... ...	7 0 0	5 3 10	66
Ficord 202 ...	7 0 0	5 3 10	66

TRUVOX HI-FI TAPE UNITS

PD.82 Standard Twin Track ...	4 4 0	3 3 0	£42
PD.84 Standard 4- Track ...	4 12 0	3 9 0	£46
PD.86 Stereo 4-Track	6 6 0	4 14 6	£63
PD.87 Stereo 1/2-Track	6 6 0	4 14 6	£63

Open all day Saturday—
Friday 6.30 p.m.

THE RECORDER CO.

If unable to call, write
for free brochure or
send deposit now for
quick delivery.

(Dept. T) 188, WEST END LANE, WEST HAMPSTEAD, LONDON, N.W.6. Telephone: SW1 4977

TAPE RECORDER COVERS



Smart, waterproof cover to give complete protection to your tape recorder. Made from rubberised canvas in navy, wine, tan, grey and bottle green with white contrasting pipings, reinforced base, handy zip microphone pocket and name panel.

Grundig TK.5	...	55/-
.. TK.8	...	63/-
.. TK.20	...	52/6
.. TK.24	...	55/-
.. TK.25	...	55/-
.. TK.30	...	60/-
.. TK.35	...	63/-
.. TK.50	...	60/-
.. TK.55	...	63/-
.. TK.60	...	75/-
.. TK.830/3D	...	63/-
.. Cub	...	35/-
Telefunken 85	...	60/-*
.. 85	...	65/-
.. 75/15	...	55/-
.. 76K	...	55/-
.. 77K
Philips 8108	...	57/6
.. 8109	...	63/-
.. EL3538	...	63/-
.. EL3542	...	63/-
.. EL3536	...	70/-*
.. EL3515	...	57/6
.. EL3541/15	...	57/6

Cossor 1602	...	57/6
.. 1601	...	63/-
Stella ST455	...	63/-
.. ST454	...	57/6
Saja MK.5	...	57/6
Scuzzi Tricorder	...	58/-
Saba	...	63/-
Wyndor Viscount	...	55/-*
.. Victor	...	60/-*
Elizabethan Princess	...	60/-
.. Avon	...	60/-
.. Escort	...	57/6*
.. Major	...	63/-
.. FT.1	...	66/-
.. FT.3
Fi-Cord	...	52/6
Korting (4 track stereo)	...	63/-
Harting Stereo	...	66/-
Fidelity Argyle	...	55/-*
Walter 101	...	55/-
Simon SP4	...	63/-*
Clarion (complete with strap)	...	52/6
Brenell Mk.5	...	77/-
.. 3 star	...	69/-
Minivox

* Without pocket
† Price to be announced

A. BROWN & SONS LTD.
24-28, GEORGE STREET, HULL Tel: 25413, 25412

QUALITY OF RECORDING DEPENDS ON THE "MIKE"

... DEPEND ON



SRI

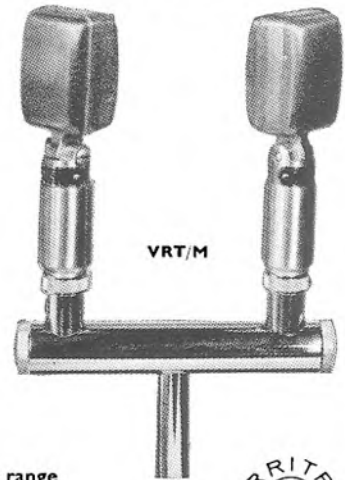

VRT/M

For further details of the wider range of microphones sound projectors and accessories contact:

RESLOSOUND LIMITED
24 Upper Brook Street, London, W.1
Telephone: Hyde Park 2291



BUILD-IT-IN OR CARRY-IT-AROUND!

▶ **new**

Tandberg

SERIES 7
STEREO TAPE RECORDER
VERSATILE — COMPACT — COMPLETE

In teak case 15 $\frac{3}{8}$ " x 11 $\frac{1}{8}$ " x 6" Weight 27 $\frac{1}{2}$ lbs.
Records and Plays Mono or Stereo

- 3 speeds 7 $\frac{1}{2}$ - 3 $\frac{3}{4}$ - 1 $\frac{7}{8}$
- 2 Indicators
- 2 Record, 2 Playback and 2 Power amplifiers (3 watts per channel)
- 2 Monitor Speakers
- 2 outputs for additional speakers or Hi-Fi

A WORTHY COMPANION TO TANDBERG SERIES 6

THE DOMESTIC DECK WITH PROFESSIONAL PERFORMANCE



Tandberg
SERIES 7

4 track model 74 93 gns.
(available October 1st)
2 track model 72 93 gns.
(available December 1st)

(Luggage type carrying case £7.1.8. extra).

Tandberg GB ELSTONE ELECTRONICS LTD., EDWARD ST., TEMPLAR ST., LEEDS 2. Tel: 3-5111

NOW!

NEW BASF

TRIPLE PLAY TAPE

GIVES YOUR PORTABLE BIG-MACHINE CAPACITY

Yes, this new BASF tape, specially developed for portable and other small-spool recorders, gives you 45 minutes continuous recording or playback at $1\frac{7}{8}$ i.p.s. — treble the playing time of Standard tape. Triple Play is thinner than other BASF tapes but has all BASF dependable qualities . . . dimensional and magnetic stability, full frequency response, negligible print through, super-smooth surface. BASF Triple Play tape is available from your dealer on 3", 4" and 4 $\frac{1}{4}$ " spools holding 450, 900 and 1200 feet respectively.

45 minutes playing time on a 3" spool



BASF TRIPLE PLAY TAPE

makes the most of your portable

BASF CHEMICALS LIMITED 5a Gillespie Rd. London N5